

FORCE[®]

TOOL STORAGE V6



Portability
speeds you up!

More Catalogues...

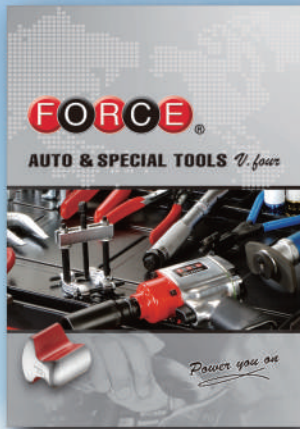

Auto & Special Tools V4



General Catalogue V9



Trolley Kit New

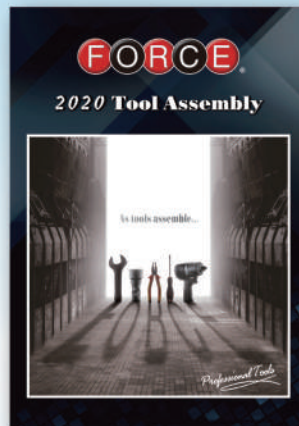

2020 Tool Assembly



INDEX

Toolbags, Suitcases, Tool Boxes, Workbenches, Carts  Page 1-1 ~ 1-48



Trolleys

 Page 2-1 ~ 2-28



Details of Tool Sets

 Page 3-1 ~ 3-48



FORCE OnDemand

 Page 4-1 ~ 4-16



Tool bag with 95pc tools

50230-95 1/10.8/11.8/1.3'
 • L53.5 x W25.8 x H22.5 cm



50230-95

1/4"DR. Part (c2421F)

	14pc	3.2; 4; 4.5; 5; 5.5; 6; 7; 8; 9; 10; 11; 12; 13; 14 mm
	1pc	QR flexible pear ratchet handle 20teeth (802218)
	2pc	2"(50mm); 6"(150mm)
	1pc	1/4"
	1pc	3/8"(F)x1/4"(M) for extension
	1pc	1/4"DR.x1/4"(F)
	1pc	Magnetic socket pick-up (25mmL)
	1pc	6"(150mm) with 1/4"DR.(F)

Bits (c2421F)

	3pc	1/4" PH.1; PH.2; PH.3 (25mmL)
	3pc	1/4" PZ.1; PZ.2; PZ.3 (25mmL)
	3pc	1/4" 4; 5.5; 6.5 mm (25mmL)
	5pc	1/4" 3; 4; 5; 6; 8 mm (25mmL)
	6pc	1/4" T10; T15; T20; T25; T30; T40 (25mmL)

Others

	1pc	PH.0 (60mmL)
	2pc	Hammer PH.1 (80mmL); PH.2 (100mmL)
	2pc	3mm (75mmL); 4mm (100mmL)
	3pc	Hammer 5.5mm (125mmL); 6.5mm (150mmL); 8mm (150mmL)
	1pc	Insulated PH.1 (80mmL)
	1pc	Insulated 4mm (100mmL)
	10pc	1.27; 1.5; 2; 2.5; 3; 4; 5; 6; 8; 10 mm (5102)
	14pc	8; 9; 10; 11; 12; 13; 14; 15; 16; 17; 18; 19; 22; 24 mm

	1pc	5055P4	Utility knife (include 3pc blades)
	1pc	5096P803	3m measuring tape
	1pc	60212150	Chisel 12 (150mmL)
	1pc	603150	Cape chisel (150mmL)
	1pc	6044190	Pin punch 4 (190mmL)
	1pc	6063185	Taper punch 3 (185mmL)
	1pc	6074185	Center punch 4 (185mmL)
	1pc	610B160	Long nose pliers 6.3"(160mm)
	1pc	611B160	Combination pliers 6.3"(160mm)
	1pc	612B160	Diagonal pliers 6.3"(160mm)
	1pc	613200	Waterpump pliers 8"(200mm)
	1pc	614175	Locking pliers 7"(175mm)
	1pc	616A400	Soft face hammer 400gw
	1pc	616F032	Reviting hammer 32mm
	1pc	617L	3-in-1 magnetic flexible pickup tool with light & mirror
	1pc	649200C	Wide-jaw adjustable wrench 8"(200mm)
	1pc	66301	Super heavy duty hacksaw
	1pc	6982	Technician's scissors 145mmL
	1pc	88407	Adjustable non-contact wire tracer

Notebook bag with 34pc tools



	2pc	PH.1 (80mmL); PH.2 (100mmL)
	3pc	4mm (100mmL); 5.5mm (125mmL); 6.5mm (150mmL)
	7pc	2.5; 3; 4; 5; 6; 8; 10 mm (5072F)
	8pc	T9; T10; T15; T20; T25; T27; T30; T40 (5083F)
	8pc	8; 10; 11; 12; 13; 14; 17; 19 mm
	1pc	Combination pliers 6.3"(160mm) (611B160)
	1pc	Diagonal pliers 6.3"(160mm) (612B160)
	1pc	Waterpump pliers 10"(250mm) (613B250)
	1pc	Ball peen hammer 16oz. (350mmL) (616B16)
	1pc	Adjustable gauged wrench 8"(200mm) (649200)
	1pc	Brass & nylon scrape brushes 3"(75mm) (9U3001)

50231-33 5/20/21/1.2'
 • L38.5 x W24 x H5 cm

Black suitcase

50234  1/4.0/4.6/1.45'
• L45 x W33 x H15 cm



Locking by key for sure security



Sturdy corners to stand up bumps.



Small but strong hook to fix case to trolley.











Black suitcase with 107pc tools





50234-107

 1/12.9/13.9/1.45'  12.9kg





1/4"DR. Part (C2421F)

	14pc	3.2; 4; 4.5; 5; 5.5; 6; 7; 8; 9; 10; 11; 12; 13; 14 mm
	1pc	QR flexible pear ratchet handle 20teeth (802218)
	2pc	2"(50mm); 6"(150mm)
	1pc	1/4"
	1pc	3/8"(F)x1/4"(M) for extension
	1pc	1/4"DR.x1/4"(F)
	1pc	Magnetic socket pick-up (25mmL)
	1pc	6"(150mm) with 1/4"DR.(F)





























1/2"DR. Part

	10pc	10; 12; 13; 14; 15; 17; 19; 21; 22; 24 mm
	1pc	QR pear ratchet handle 24teeth (80242)

Bits (C2421F)

	3pc	1/4" PH.1; PH.2; PH.3 (25mmL)
	3pc	1/4" PZ.1; PZ.2; PZ.3 (25mmL)
	3pc	1/4" 4; 5.5; 6.5 mm (25mmL)
	5pc	1/4" 3; 4; 5; 6; 8 mm (25mmL)
	6pc	1/4" T10; T15; T20; T25; T30; T40 (25mmL)

Others

	1pc	PH.2 (25mmL)	
	3pc	PH.1 (80mmL); PH.2 (100mmL); PH.3 (150mmL)	
	1pc	6.5mm (25mmL)	
	2pc	Insulated PH.1 (80mmL); PH.2 (100mmL)	
	4pc	Insulated 3mm (100mmL); 4mm (100mmL); 5.5mm (125mmL); 6.5mm (150mmL)	
	10pc	1.27; 1.5; 2; 2.5; 3; 4; 5; 6; 8; 10 mm (5102LB)	
	11pc	8; 10; 11; 12; 13; 14; 15; 17; 19; 21; 22 mm (5115)	
	1pc	5055P4 Utility knife (include 3pc blades)	
	1pc	5096P2 Auto center punch	
	1pc	5096P8 5m measuring tape	
	1pc	60212150 Chisel 12 (150mmL)	(€5054)
	1pc	603150 Cape chisel (150mmL)	(€5054)
	1pc	6044190 Pin punch 4 (190mmL)	(€5054)
	1pc	6063185 Taper punch 3 (185mmL)	(€5054)
	1pc	6074185 Center punch 4 (185mmL)	(€5054)
	1pc	614250 Locking pliers 10"(250mm)	
	1pc	616300 Engineer hammer 300gw	
	1pc	616400 Rubber hammer 400gw (280mmL)	
	1pc	649250A Adjustable gauged wrench 10"(250mm)	
	1pc	66302 Mini hacksaw frame 6"	
	2pc	5055P3 Saw blade	
	1pc	68607A Flash light with zoom in/out function	
	1pc	6903180 Insulated combination pliers 7"(180mm)	
	1pc	6904160 Insulated long nose pliers 6.3"(160mm)	
	1pc	6905160 Insulated diagonal cutting pliers 6.3"(160mm)	
	1pc	6907250 Insulated water pump pliers 10"(250mm)	
	1pc	6912160 Insulated wire stripper pliers 6.3"(160mm)	
	1pc	88407 Adjustable non-contact wire tracer	

3-Layer / 5-Layer tool box



50233 1/6/7/1.5'
• L53.5 x W25.8 x H16.5 cm

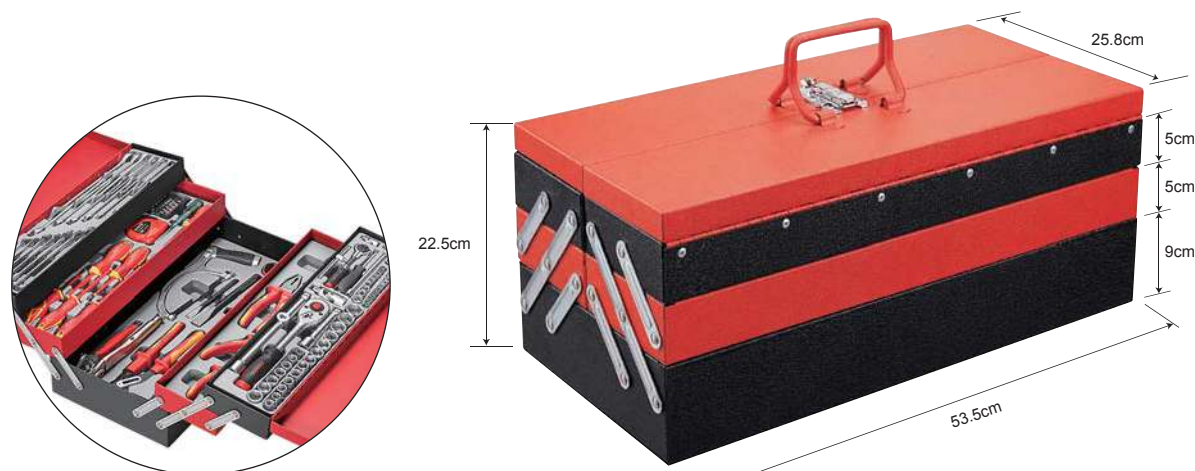

50235 1/7.6/9/1.9'
• L53.5 x W25.8 x H22.5 cm

3-Layer tool box with 79pc tools



50233-80 1/15.7/16.7/1.5'



Upper layer - 1st



Upper layer - 2nd



Lower layer - 1st



Lower layer - 2nd

Upper layer - 1st (50233-80)



1/2"DR.	
	15pc 10; 11; 12; 13; 14; 15; 16; 17; 18; 19; 22; 24; 27; 30; 32 mm
	1pc QR pear ratchet handle 24teeth (80242)
	2pc 5"(125mm); 10"(250mm)
	1pc 10"(250mm)
	1pc 1/2"

Upper layer - 2nd (50233-80)



	20pc 6; 7; 8; 9; 10; 11; 12; 13; 14; 15; 16; 17; 18; 19; 20; 22; 23; 24; 27; 28 mm
--	--

Lower layer - 1st (50233-80)



	2pc PH.1 (80mmL); PH.2 (100mmL)
	3pc 5.5mm (125mmL); 6.5mm (150mmL); 8mm (175mmL)
	1pc Hammer 12mm (200mmL)
	11pc 1.5; 2; 2.5; 3; 4; 5; 6; 7; 8; 10; 12 mm (5116)
	8pc T9; T10; T15; T20; T25; T27; T30; T40 (5083F)
	1pc 500gw (616500)

Lower layer - 2nd (50233-80)



	1pc 750380 Tyre lever 380mmL
	2pc 755 30...32 Combination wrench 30; 32 mm
	1pc 60212150 Chisel 12 (150mmL) (€ 5054)
	1pc 603150 Cape chisel (150mmL) (€ 5054)
	1pc 6044190 Pin punch 4 (190mmL) (€ 5054)
	1pc 6063185 Taper punch 3 (185mmL) (€ 5054)
	1pc 6074185 Center punch 4 (185mmL) (€ 5054)
	1pc 610B200 Long nose pliers 8"(200mm)
	1pc 611B200 Combination pliers 8"(200mm)
	1pc 612B175 Diagonal pliers 7"(175mm)
	1pc 613B250 Waterpump pliers 10"(250mm)
	1pc 614250 Locking pliers 10"(250mm)

5-Layer tool box with 152pc tools



50235-152 1/20.3/21.3/1.9'

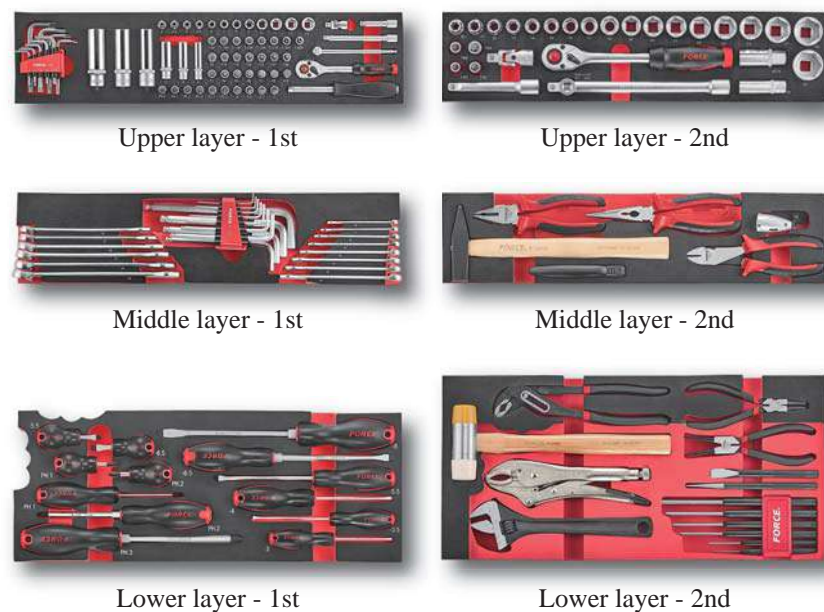

Upper layer - 1st (50235-152)



1/4"DR. Part	
	12pc 4; 4.5; 5; 5.5; 6; 7; 8; 9; 10; 11; 12; 13 mm
	3pc 8; 10; 12 mm (50mmL)
	4pc PH.0; PH.1; PH.2; PH.3 (32mmL)
	2pc PZ.1; PZ.2 (32mmL)
	4pc 4; 5.5; 6.5; 7 mm (32mmL)
	7pc 3; 4; 5; 6; 7; 8; 10 mm (32mmL)
	7pc T8; T10; T15; T20; T25; T27; T30 (32mmL)
	8pc T-8H; T-10H; T-15H; T-20H; T-25H; T-27H; T-30H; T-40H (32mmL)
	1pc QR pear ratchet handle 72teeth (80228)
	2pc 2"(50mm); 4"(100mm)
	1pc 4.5"(115mm)
	1pc 1/4"
	1pc 6"(150mm) with 1/4"DR.(F)

Others	
	9pc T10; T15; T20; T25; T27; T30; T40; T45; T50 (5098)

1/2"DR. Part	
	3pc 13; 17; 19 mm (77mmL)

5-Layer tool box with 187pc tools



50235-187 1/20.4/21.4/1.9'

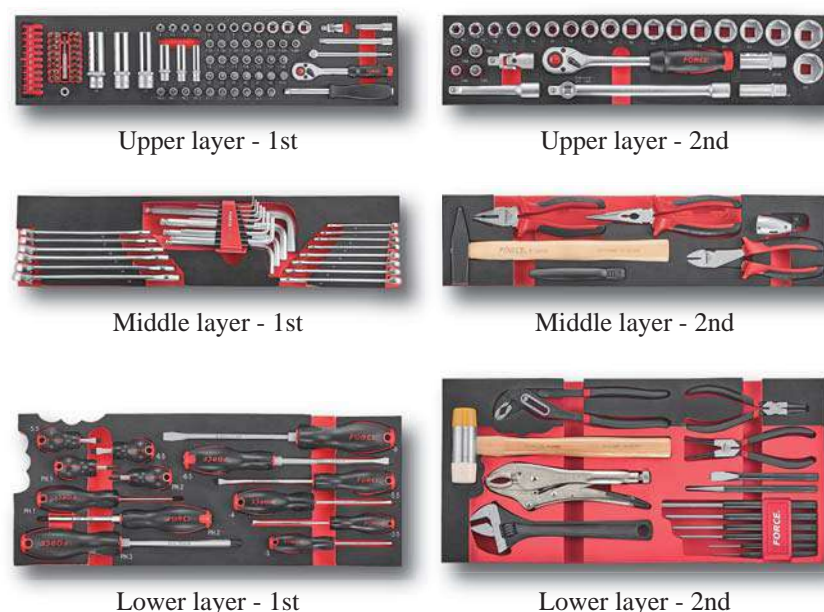

Upper layer - 1st (50235-187)



Bits	
	6pc 1/4" 2; 4; 6; 8; 10 mm; 1/4" (25mmL) (C2331A)
	4pc 1/4" 1; 2; 3; 4 (25mmL) (C2331A)
	6pc 1/4" 4; 6; 8; 10; 12; 14 mm (25mmL) (C2331A)
	4pc 1/4" No.0; No.1; No.2; No.3 (25mmL) (C2331A)
	6pc 1/4" 2; 2.5; 3; 4; 5; 6 mm (25mmL) (C2331A)
	6pc 1/4" 5/64"; 3/32"; 7/64"; 1/8"; 9/64"; 5/32" (25mmL) (C2331A)
	1pc Magnetic 1/4"Hex-1/4"Hex 2.3"(60mm) (E2331A)
	10pc 1/4" TS8; TS10; TS15; TS20; TS25; TS27; TS30; TS40; TS45; TS50 (25mmL) (21013)

1/4"DR. Part	
	12pc 4; 4.5; 5; 5.5; 6; 7; 8; 9; 10; 11; 12; 13 mm
	3pc 8; 10; 12 mm (50mmL)
	4pc PH.0; PH.1; PH.2; PH.3 (32mmL)
	2pc PZ.1; PZ.2 (32mmL)
	4pc 4; 5.5; 6.5; 7 mm (32mmL)
	7pc 3; 4; 5; 6; 7; 8; 10 mm (32mmL)
	7pc T8; T10; T15; T20; T25; T27; T30 (32mmL)
	8pc T-8H; T-10H; T-15H; T-20H; T-25H; T-27H; T-30H; T-40H (32mmL)
	1pc QR pear ratchet handle 72teeth (80228)
	2pc 2"(50mm); 4"(100mm)
	1pc 4.5"(115mm)
	1pc 1/4"
	1pc 1/4"DR.x1/4"(F)
	1pc 6"(150mm) with 1/4"DR.(F)

1/2"DR. Part	
	3pc 13; 17; 19 mm (77mmL)

Upper layer - 2nd (50235-152 & 50235-187)



1/2"DR.

	18pc	10; 11; 12; 13; 14; 15; 16; 17; 18; 19; 20; 21; 22; 23; 24; 27; 30; 32 mm
	2pc	Spark plug 16; 20.6 mm
	4pc	T40; T45; T50; T55 (55mmL)
	1pc	QR pear ratchet handle 72teeth (80248)
	2pc	5"(125mm); 10"(250mm)
	1pc	1/2"
	1pc	3/8"(F)x1/2"(M) for extension

Middle layer - 1st (50235-152 & 50235-187)



	11pc	1.5; 2; 2.5; 3; 4; 5; 6; 7; 8; 10; 12 mm (5116LB)
	14pc	6; 7; 8; 9; 10; 11; 12; 13; 14; 15; 16; 17; 18; 19 mm

Middle layer - 2nd (50235-152 & 50235-187)



	1pc	610B200 Long nose pliers 8"(200mm)
	1pc	611B175 Combination pliers 7"(175mm)
	1pc	612B175 Diagonal pliers 7"(175mm)
	1pc	616300 Engineer hammer 300gw
	1pc	68021 Electrician folding knife
	1pc	68601 LED white light, clip-type (360° rotation)

Lower layer - 1st (50235-152 & 50235-187)



	2pc	PH.1; PH.2 (25mmL)
	2pc	PH.1 (80mmL); PH.3 (150mmL)
	1pc	Hammer PH.2 (100mmL)
	2pc	5.5; 6.5mm (25mmL)
	5pc	3mm (75mmL); 3.5mm (100mmL); 4mm (100mmL); 5.5mm (125mmL); 8mm (175mmL)
	1pc	Hammer 6.5mm (150mmL)

Lower layer - 2nd (50235-152 & 50235-187)



	1pc	60212150 Chisel 12 (150mmL)
	1pc	6042140 Pin punch 2 (140mmL) (€50613)
	1pc	6043150 Pin punch 3 (150mmL) (€50613)
	1pc	6044190 Pin punch 4 (190mmL) (€50613)
	1pc	6045200 Pin punch 5 (200mmL) (€50613)
	1pc	6046210 Pin punch 6 (210mmL) (€50613)
	1pc	6048215 Pin punch 8 (215mmL) (€50613)
	1pc	6074185 Center punch 4 (185mmL)
	1pc	609ABC Snap ring pliers (bent-close) 7"(180mm)
	1pc	609ASO Snap ring pliers (straight-open) 7"(180mm)
	1pc	613B250 Waterpump pliers 10"(250mm)
	1pc	614250 Locking pliers 10"(250mm)
	1pc	616A400 Soft face hammer 400gw
	1pc	649250 Adjustable gauged wrench 10"(250mm)



3-Layer tool box with 76pc tools



50233-76  1/13.8/14.8/1.5'



3-Layer tool box with 25pc insulated tools



50233-25  1/10.9/11.9/1.5'

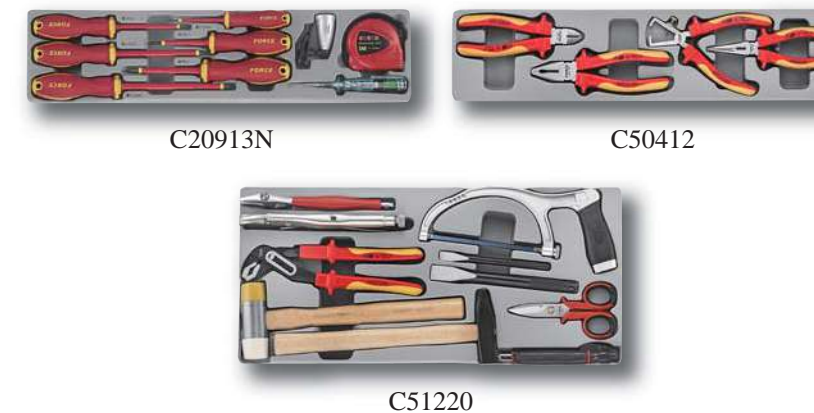

5-Layer tool box with 101pc tools



50235-101  1/18.2/19.2/1.9'



5-Layer tool box with 88pc insulated tools



50235-88  1/18.2/19.2/1.9'



5-Layer tool box with 124pc tools (S&M)



50235-124  1/17.9/18.9/1.9'
• C3661 changed to C4542, you get **50235-112**



5-Layer tool box with 109pc insulated tools (S&M)



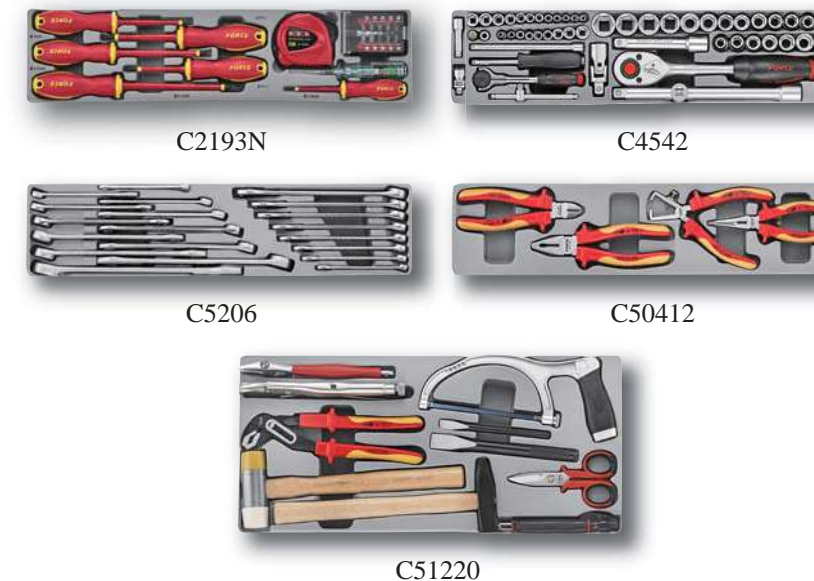

50235-110  1/18.8/19.8/1.9'



15pc Combination wrench set







C5153  10/22.1/23.1/1.1'  2210g

	15pc	8; 10; 11; 12; 13; 14; 15; 16; 17; 18; 19; 21; 22; 23; 24 mm
---	------	--

20pc Combination wrench set (S&M)



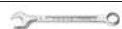





C5206  10/23/24/1.3'  2300g

	12pc	8; 10; 11; 12; 13; 14; 15; 16; 17; 19; 22; 24 mm
	8pc	5/16"; 3/8"; 7/16"; 1/2"; 9/16"; 5/8"; 11/16"; 3/4"

16pc Wrench and pliers set









C5166  10/16.5/17.5/1.2'  1650g

	13pc	755 06...22	Combination wrench 6; 7; 8; 9; 10; 11; 12; 13; 14; 15; 17; 19; 22 mm
	1pc	610B160	Long nose pliers 6.3"(160mm)
	1pc	611B160	Combination pliers 6.3"(160mm)
	1pc	612B160	Diagonal pliers 6.3"(160mm)

14pc Pliers and L key set









C5142  10/14.4/15.4/0.8'  1440g

	10pc	764 0127...10	Hex key 1.27; 1.5; 2; 2.5; 3; 4; 5; 6; 8; 10 mm (5102)
	1pc	610B200	Long nose pliers 8"(200mm)
	1pc	611B175	Combination pliers 7"(175mm)
	1pc	612B175	Diagonal pliers 7"(175mm)
	1pc	613B250	Waterpump pliers 10"(250mm)

4pc Insulated pliers set















C50412  10/8.5/9.5/0.8'  850g

	1pc	6903180	Insulated combination pliers 7"(180mm)
	1pc	6904160	Insulated long nose pliers 6.3"(160mm)
	1pc	6905160	Insulated diagonal cutting pliers 6.3"(160mm)
	1pc	6912160	Insulated wire stripper pliers 6.3"(160mm)

12pc Utility set



C51220  6/18.5/19.5/1.5'  3120g

	1pc	5055P4	Utility knife (include 3pc blades)
	1pc	60212150	Chisel 12 (150mmL)
	1pc	60219200	Chisel 19 (200mmL)
	1pc	614250	Locking pliers 10"(250mm)
	1pc	616300	Engineer hammer 300gw
	1pc	616A400	Soft face hammer 400gw
	1pc	649200C	Wide-jaw adjustable wrench 8"(200mm)
	1pc	66302	Mini hacksaw frame 6"
	2pc	5055P3	Saw blade
	1pc	6907250	Insulated water pump pliers 10"(250mm)
	1pc	6982	Technician's scissors 145mmL

12pc Utility set

















C51221  6/18.4/19.4/1.5'  3060g

	1pc	5055P4	Utility knife (include 3pc blades)
	1pc	60212150	Chisel 12 (150mmL)
	1pc	60219200	Chisel 19 (200mmL)
	1pc	613B250	Waterpump pliers 10"(250mm)
	1pc	614250	Locking pliers 10"(250mm)
	1pc	616300	Engineer hammer 300gw
	1pc	616A400	Soft face hammer 400gw
	1pc	649200C	Wide-jaw adjustable wrench 8"(200mm)
	1pc	66302	Mini hacksaw frame 6"
	2pc	5055P3	Saw blade
	1pc	6982	Technician's scissors 145mmL

13pc Utility set



C5136  6/18.6/19.6/1.3'  3100g

	1pc	5055P4	Utility knife (include 3pc blades)
	1pc	5096P8	5m measuring tape
	1pc	60215180Q	Chisel 15 (180mmL)
	1pc	6044190Q	Pin punch 4 (190mmL)
	1pc	6045200Q	Pin punch 5 (200mmL)
	1pc	6046210Q	Pin punch 6 (210mmL)
	1pc	614250	Locking pliers 10"(250mm)
	1pc	616300	Engineer hammer 300gw
	1pc	616400	Rubber hammer 400gw (280mmL)
	1pc	649250A	Adjustable gauged wrench 10"(250mm)
	1pc	66302	Mini hacksaw frame 6"
	2pc	5055P3	Saw blade

3-Drawer / 9-Drawer black tool box



50223S  1/11.5/12.5/2.2'
• L55.5 x W24 x H28 cm



50229S  1/28.2/29.2/4.3'
• L65.5 x W31 x H43 cm

3-Drawer black tool box with 116pc tools



50223S-116-5  1/20.1/21.1/2.2'

DT
DB1
DB2
DB3



DT



DB1



DB2



DB3









DT (50223S-116-5)









4721-5

 5/20.7/21.7/2.2'  4140g





1/4"DR. Part

	12pc	4; 4.5; 5; 5.5; 6; 7; 8; 9; 10; 11; 12; 13 mm
	3pc	8; 10; 13 mm (50mmL)
	1pc	QR pear ratchet handle 20teeth (802215)
	1pc	2"(50mm)
	1pc	4.5"(115mm)
	1pc	1/4"
	1pc	1/4"DR.x1/4"(F)
	1pc	Magnetic 1/4"DR.x1/4"(F)
	1pc	6"(150mm) with 1/4"DR.(F)

1/2"DR. Part

	13pc	14; 15; 16; 17; 18; 19; 20; 21; 22; 24; 27; 30; 32 mm
	3pc	17; 19; 21 mm (77mmL)
	1pc	QR thin pear ratchet handle 24teeth (80243)
	2pc	3"(75mm); 10"(250mm)
	1pc	Wobble extension 5"(125mm)
	1pc	1/2"
	1pc	3/8"(F)x1/2"(M) for extension

Bits

	4pc	1/4" PH.0; PH.1; PH.2; PH.3 (30mmL)
	4pc	1/4" PZ.0; PZ.1; PZ.2; PZ.3 (30mmL)
	5pc	1/4" 4; 5; 5.5; 6; 7 mm (30mmL)
	8pc	1/4" 2; 3; 4; 5; 5.5; 6; 7; 8 mm (30mmL)
	7pc	1/4" T10; T15; T20; T25; T27; T30; T40 (30mmL)

DB1 (50223S-116-5)



20914

5/6.0/7.0/1.4' 1200g

	1pc	PH.2 (25mmL)
	3pc	PH.1 (80mmL); PH.2 (100mmL); PH.3 (150mmL)
	1pc	6.5mm (25mmL)
	4pc	4mm (100mmL); 5.5mm (125mmL); 6.5mm (150mmL); 8mm (175mmL)

DB2 (50223S-116-5)



5252

5/10.7/11.7/1.4' 2140g

	9pc	1.5; 2; 2.5; 3; 4; 5; 6; 8; 10 mm (5093LB)
	16pc	6; 7; 8; 9; 10; 11; 12; 13; 14; 15; 16; 17; 18; 19; 22; 24 mm

DB3 (50223S-116-5)



51012

5/9.4/10.4/1.4' 1880g

	1pc	60212150	Chisel 12 (150mmL)
	1pc	603150	Cape chisel (150mmL)
	1pc	6043150	Pin punch 3 (150mmL)
	1pc	6044190	Pin punch 4 (190mmL)
	1pc	6074185	Center punch 4 (185mmL)
	1pc	610B200	Long nose pliers 8"(200mm)
	1pc	611B175	Combination pliers 7"(175mm)
	1pc	612B175	Diagonal pliers 7"(175mm)
	1pc	613B250	Waterpump pliers 10"(250mm)
	1pc	616200	Engineer hammer 200gw

3-Drawer black tool box with 147pc tools (SAE)



50223S-147

1/24.9/26.0/2.2'

	DT
	DB1
	DB2
	DB3



DT



DB1



DB2



DB3

DT (50223S-147)



	5pc	5/16"x3/8"; 3/8"x7/16"; 1/2"x9/16"; 5/8"x3/4"; 11/16"x3/4"
	17pc	1/4"; 5/16"; 3/8"; 7/16"; 1/2"; 9/16"; 5/8"; 11/16"; 3/4"; 13/16"; 7/8"; 15/16"; 1"; 1-1/16"; 1-1/8"; 1-1/4"; 1-5/16"

DB1 (50223S-147)



1/4"DR. Part	
	11pc 5/32"; 3/16"; 7/32"; 1/4"; 9/32"; 5/16"; 11/32"; 3/8"; 7/16"; 1/2"; 9/16"
	5pc E4; E5; E6; E7; E8
	1pc Round ratchet handle 72teeth (80229)
	3pc 2"(50mm); 4"(100mm); 6"(150mm)
	1pc 1/4"
	1pc 3/8"(F)x1/4"(M) for extension
	1pc 1/4"DR.x1/4"(F)
	1pc Magnetic socket pick-up (25mmL)
	1pc 6"(150mm) with 1/4"DR.(F)

Bits	
	4pc 1/4" PH.0; PH.1; PH.2; PH.3 (25mmL)
	4pc 1/4" PZ.0; PZ.1; PZ.2; PZ.3 (25mmL)
	5pc 1/4" 4; 5; 5.5; 6.5; 7 mm (25mmL)
	8pc 1/4" 1/16"; 3/32"; 1/8"; 5/32"; 3/16"; 1/4"; 5/16"; 3/8" (25mmL)
	7pc 1/4" T10; T15; T20; T25; T27; T30; T40 (25mmL)

Others	
	10pc 1/16"; 5/64"; 3/32"; 1/8"; 5/32"; 3/16"; 1/4"; 5/16"; 3/8"; 1/2" (5109S)

3/8"DR. Part	
	14pc 1/4"; 5/16"; 3/8"; 7/16"; 1/2"; 9/16"; 19/32"; 5/8"; 11/16"; 3/4"; 25/32"; 13/16"; 7/8"; 15/16"
	1pc Round ratchet handle 72teeth (80239)
	2pc 3"(75mm); 6"(150mm)
	1pc 3/8"
	1pc 1/2"(F)x3/8"(M) for extension

DB2 (50223S-147)



1/2"DR.

	19pc	5/16"; 3/8"; 7/16"; 15/32"; 1/2"; 9/16"; 19/32"; 5/8"; 11/16"; 3/4"; 25/32"; 13/16"; 7/8"; 15/16"; 1"; 1-1/16"; 1-1/8"; 1-3/16"; 1-1/4"
	6pc	E10; E12; E14; E16; E18; E20
	2pc	Spark plug 16mm (5/8"); 20.6mm (13/16")
	1pc	Round ratchet handle 72teeth (80249)
	1pc	17"(430mm)
	2pc	3"(75mm); 10"(250mm)
	1pc	1/2"
	1pc	3/8"(F)x1/2"(M) for extension
	1pc	10.2"(260mm)

DB3 (50223S-147)



	1pc	PH.1 (25mmL)
	1pc	PH.1 (80mmL)
	1pc	Hammer PH.2 (100mmL)
	1pc	5.5mm (25mmL)
	1pc	5.5mm (125mmL)
	1pc	Hammer 6.5mm (150mmL)
	1pc	Combination pliers 7"(175mm) (611B175)
	1pc	Locking pliers 10"(250mm) (614250)
	1pc	Engineer hammer 300gw (616300)

3-Drawer black tool box with 109pc tools (S&M)



50223S-109 1/23.6/24.6/2.2'

DT
DB1
DB2
DB3



DT



DB1



DB2



DB3

DT (50223S-109)



5262

5/4.1/5.1/2.2' 820g

	9pc	Hex ball point extra long key 1.5; 2; 2.5; 3; 4; 5; 6; 8; 10 mm (5093XLB)
	9pc	Hex ball point extra long key 1/16"; 5/64"; 3/32"; 1/8"; 5/32"; 3/16"; 1/4"; 5/16"; 3/8" (5093XLBS)
	1pc	Long nose pliers 8"(200mm) (610B200)
	1pc	Combination pliers 7"(175mm) (611B175)
	1pc	Diagonal pliers 7"(175mm) (612B175)
	1pc	Waterpump pliers 10"(250mm) (613250)
	1pc	Locking pliers 10"(250mm) (614250)
	1pc	Long nose locking pliers 9"(225mm) (615225)
	1pc	Adjustable gauged wrench 10"(250mm) (649250A)
	1pc	Slip joint pliers 8.5"(215mm) (673B215)

DB1 (50223S-109)



2146

5/4.1/5.1/1.4' 820g

	2pc	5/16" PH.2; PH.3 (36mmL)
	2pc	5/16" 9; 11 mm (36mmL)
	1pc	1/2"DR.x5/16"(F)
	1pc	1/2"DR. Impact driver (8174)
	2pc	PH.1 (80mmL); PH.2 (100mmL); 3mm (75mmL); 3.5mm (100mmL);
	6pc	4mm (100mmL); 5.5mm (125mmL); 6.5mm (150mmL); 8mm (175mmL)

DB2 (50223S-109)



3451V

5/18.9/19.9/1.4' 3775g

3/8"DR.

	15pc	8; 9; 10; 11; 12; 13; 14; 15; 16; 17; 18; 19; 20; 21; 22 mm
	5pc	3/8"; 1/2"; 9/16"; 11/16"; 13/16"
	11pc	8; 9; 10; 11; 12; 13; 14; 16; 17; 19; 22 mm (63mmL)
	5pc	3/8"; 1/2"; 9/16"; 11/16"; 13/16" (63mmL)
	3pc	Spark plug 16mm (5/8"); 18mm; 20.6mm (13/16")
	1pc	QR pear ratchet handle 36teeth (80235)
	1pc	Bent 8"(200mm)
	2pc	3"(75mm); 6"(150mm)
	1pc	3/8"
	1pc	1/2"(F)x3/8"(M) for extension

DB3 (50223S-109)



5243

5/14.1/15.1/1.4' 2786g

	12pc	8; 10; 11; 12; 13; 14; 15; 16; 17; 19; 22; 23 mm
	12pc	1/4"; 5/16"; 3/8"; 7/16"; 1/2"; 9/16"; 5/8"; 11/16"; 3/4"; 13/16"; 7/8"; 15/16"

9-Drawer black tool box with 255pc tools (S&M)



50229S-255

1/51.4/53/4.3'

DT		
DL1	DC1	DR1
DL2	DC2	DR2
DB1		
DB2		
DB3		



DT



DL1



DC1



DL2



DC2



DR2



DB1

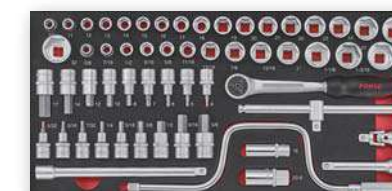

DB2



DB3

DT (50229S-255)



2145

4/9.8/10.8/1.6' 2443g

	2pc	PH.1 (80mmL); PH.2 (100mmL)
	6pc	3mm (75mmL); 3.5mm (100mmL); 4mm (100mmL); 5.5mm (125mmL); 6.5mm (150mmL); 8mm (175mmL)
	1pc	Long nose pliers 8"(200mm) (610B200)
	1pc	Bent long nose pliers 8"(200mm) (610B200B)
	1pc	Combination pliers 7"(175mm) (611B175)
	1pc	Diagonal pliers 7"(175mm) (612B175)
	1pc	Adjustable gauged wrench 8"(200mm) (649200E)
	1pc	Adjustable gauged wrench 12"(300mm) (649300E)

DL1 (50229S-255)

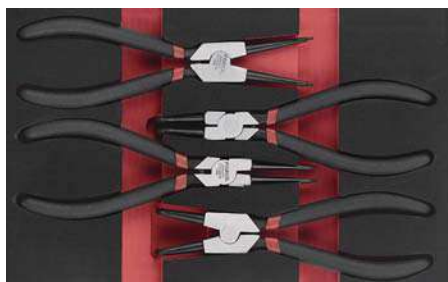

5043AV

10/6.6/7.6/1.1' Δ 660g

	1pc	609ABC	Snap ring pliers (bent-close) 7"(180mm)
	1pc	609ABO	Snap ring pliers (bent-open) 7"(180mm)
	1pc	609ASC	Snap ring pliers (straight-close) 7"(180mm)
	1pc	609ASO	Snap ring pliers (straight-open) 7"(180mm)

DC1 (50229S-255)



51223

10/13/14/1.1' Δ 1300g

	2pc	5/16" PH.2; PH.3 (36mmL)
	2pc	5/16" 9; 11 mm (36mmL)
	1pc	1/2"DR.x5/16"(F)
	1pc	1/2"DR. Impact driver (8174)
	6pc	Pin punch 2 (140mmL); 3 (150mmL); 4 (190mmL); 5 (200mmL); 6 (210mmL); 8 (215mmL) (50613)

DL2 (50229S-255)



5066V

10/6.2/7.2/1.1' Δ 624g

	6pc	8x10; 10x11; 10x12; 11x13; 12x14; 17x19 mm
--	-----	--

DC2 (50229S-255)



5066SV

10/7.5/8.5/1.1' Δ 754g

	6pc	5/16"x3/8"; 3/8"x7/16"; 7/16"x1/2"; 1/2"x9/16"; 5/8"x3/4"; 11/16"x3/4"
--	-----	---

DR2 (50229S-255)

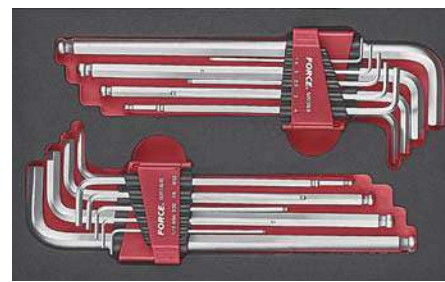

5184

10/8.9/9.9/1.1' Δ 890g

	9pc	1.5; 2; 2.5; 3; 4; 5; 6; 8; 10 mm (5093XLB)
	9pc	1/16"; 5/64"; 3/32"; 1/8"; 5/32"; 3/16"; 1/4"; 5/16"; 3/8" (5093XLBS)

DB1 (50229S-255)



31101

4/19.0/20.0/1.89' Δ 4759g

1/4"DR. Part	
	13pc 4; 4.5; 5; 5.5; 6; 7; 8; 9; 10; 11; 12; 13; 14 mm
	10pc 3/16"; 7/32"; 1/4"; 9/32"; 5/16"; 11/32"; 3/8"; 7/16"; 1/2"; 9/16"
	1pc Round ratchet handle 72teeth (802222)
	2pc 2"(50mm); 6"(150mm)
	1pc 1/4"
	1pc 1/4"(F)x1/4"(M) for extension
	1pc 1/4"DR.x1/4"(F)
	1pc Flexible extension 5.8"(145mm)
	1pc 6"(150mm) with 1/4"DR.(F)

Bits (2331)

	3pc	1/4" 6; 8; 10 mm (25mmL)
	4pc	1/4" 1; 2; 3; 4 (25mmL)
	4pc	1/4" 4; 6; 8; 10 mm (25mmL)
	6pc	1/4" 2; 2.5; 3; 4; 5; 6 mm (25mmL)
	6pc	1/4" 5/32"; 9/64"; 1/8"; 7/64"; 3/32"; 5/64" (25mmL)
	9pc	1/4" T-8H; T-10H; T-15H; T-20H; T-25H; T-27H; T-30H; T-35H; T-40H (25mmL)
	1pc	Magnetic 1/4"Hex-1/4"Hex 2.3"(60mm)

3/8"DR. Part

	15pc	8; 9; 10; 11; 12; 13; 14; 15; 16; 17; 18; 19; 20; 21; 22 mm
	5pc	3/8"; 1/2"; 9/16"; 11/16"; 13/16"
	11pc	8; 9; 10; 11; 12; 13; 14; 16; 17; 19; 22 mm (63mmL)
	5pc	3/8"; 1/2"; 9/16"; 11/16"; 13/16" (63mmL)
	3pc	Spark plug 16mm (5/8"); 18mm; 20.6mm (13/16")
	1pc	20-100 Nm, 420mmL (6473420W)
	1pc	Round ratchet handle 72teeth (802322)
	1pc	Bent 8"(200mm)
	2pc	3"(75mm); 6"(150mm)
	1pc	3/8"
	1pc	1/2"(F)x3/8"(M) for extension



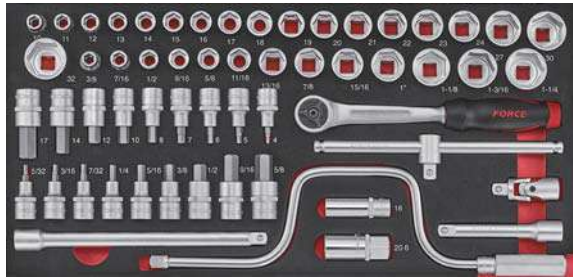







DB2 (50229S-255)



4572

4/11.0/12.0/1.89' ⚖️ 2757g

1/2"DR.

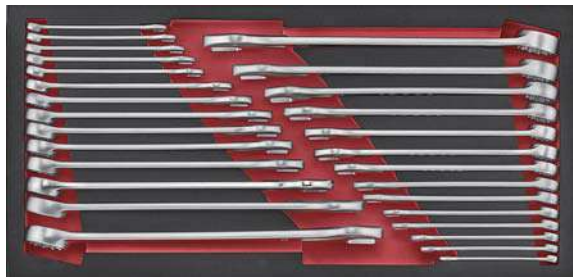

	18pc	10; 11; 12; 13; 14; 15; 16; 17; 18; 19; 20; 21; 22; 23; 24; 27; 30; 32 mm
	13pc	3/8"; 7/16"; 1/2"; 9/16"; 5/8"; 11/16"; 13/16"; 7/8"; 15/16"; 1"; 1-1/8"; 1-3/16"; 1-1/4"
	2pc	Spark plug 16mm (5/8"); 20.6mm (13/16")
	9pc	4; 5; 6; 7; 8; 10; 12 mm (55mmL) 14mm (65mmL) 17mm (70mmL)
	9pc	5/32"; 3/16"; 7/32"; 1/4"; 5/16"; 3/8"; 1/2" (55mmL) 9/16"; 5/8" (65mmL)
	1pc	Round ratchet handle 72teeth (802422)
	2pc	5"(125mm); 10"(250mm)
	1pc	10"(250mm)
	1pc	1/2"
	1pc	16.3"(415mm)

DB3 (50229S-255)



5281

4/17.3/18.3/1.89' ⚖️ 4322g

	14pc	10; 11; 12; 13; 14; 17; 19; 21; 22; 23; 24; 27; 30; 32 mm
	14pc	5/16"; 3/8"; 7/16"; 1/2"; 9/16"; 5/8"; 11/16"; 3/4"; 13/16"; 7/8"; 15/16"; 1"; 1-1/8"; 1-1/4"

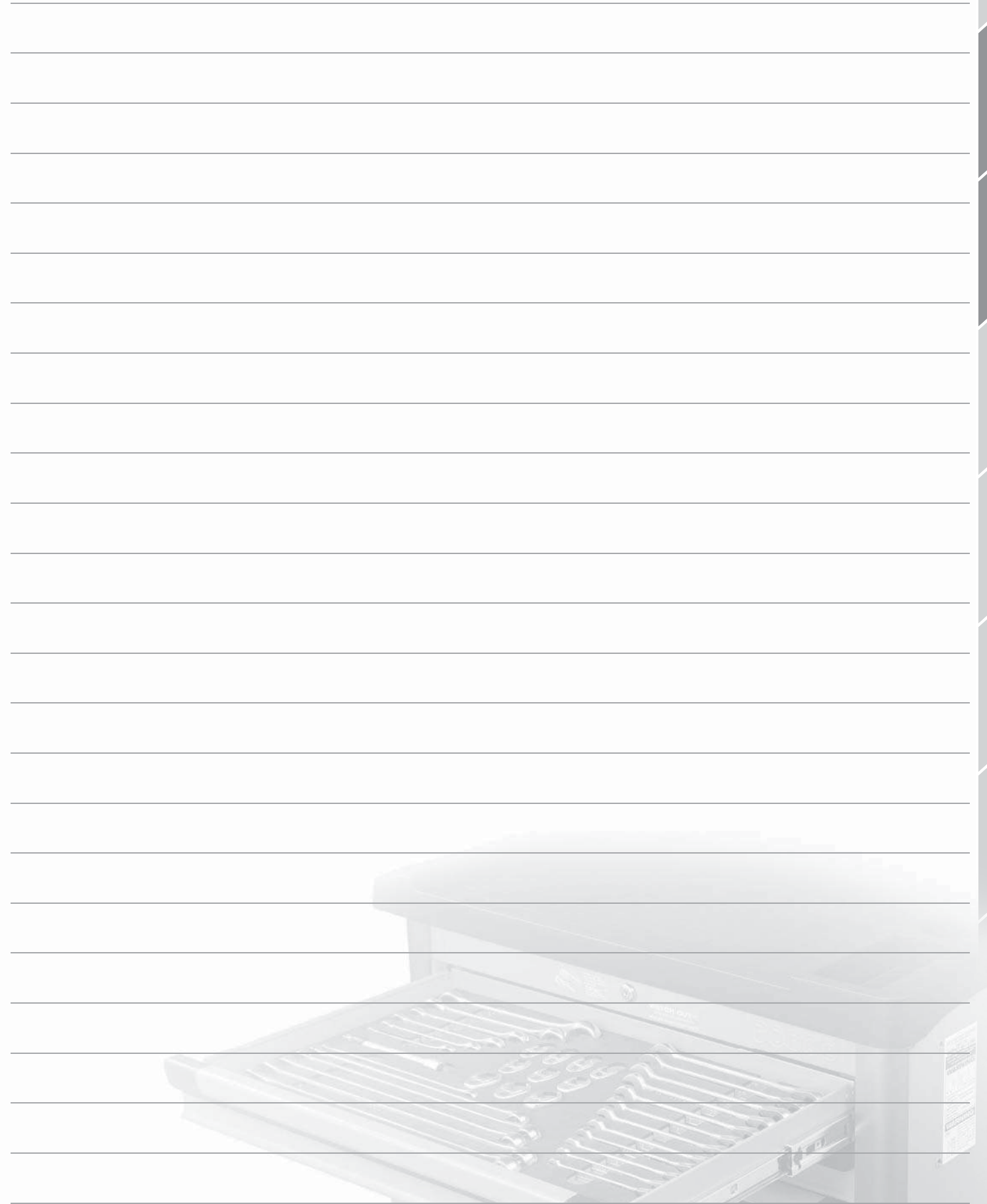

Glory boxes (with glossy paint)

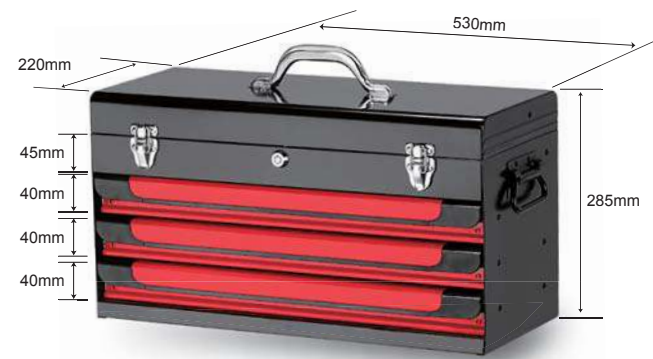

10523 1/9.8/10.6/2'
• L530 x W220 x H285 mm



10526 1/22/25/4.8'
• L660 x W307 x H379 mm



10529 1/29/32/4.8'
• L660 x W307 x H434 mm

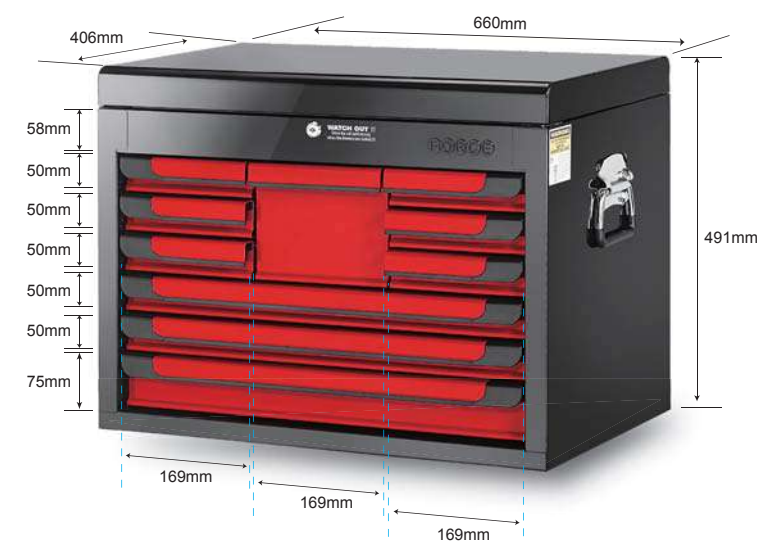

1052D 1/40/41.7/7'
• L660 x W406 x H491 mm

Glory red & black 3-drawer top chest with 131pc tools (S&M)



10523-131 1/20.6/21.4/2'

DT
DB1
DB2
DB3



DT



DB1



DB2



DB3

DT (10523-131)



3/8"DR.

	19pc	6; 7; 8; 9; 10; 11; 12; 13; 14; 15; 16; 17; 18; 19; 20; 21; 22; 23; 24 mm
	12pc	1/4"; 5/16"; 3/8"; 7/16"; 1/2"; 9/16"; 5/8"; 11/16"; 3/4"; 13/16"; 7/8"; 15/16"
	11pc	8; 10; 11; 12; 13; 14; 15; 16; 17; 18; 19 mm (63mmL)
	8pc	5/16"; 3/8"; 7/16"; 1/2"; 9/16"; 5/8"; 11/16"; 3/4" (63mmL)
	12pc	E4; E5; E6; E7; E8; E10; E11; E12; E14; E16; E18; E20
	7pc	3; 4; 5; 6; 7; 8; 10 mm (50mmL)
	7pc	1/8"; 5/32"; 3/16"; 7/32"; 1/4"; 5/16"; 3/8" (50mmL)
	8pc	T20; T25; T27; T30; T40; T45; T50; T55 (50mmL)
	1pc	QR pear ratchet handle 72teeth (80238)
	2pc	3"(75mm); 6"(150mm)
	1pc	Wobble extension 10"(250mm)
	1pc	6.5"(165mm)
	1pc	3/8"

DB1 (10523-131)



	1pc	PH.2 (25mmL)
	2pc	PH.1 (80mmL); PH.2 (100mmL)
	1pc	6.5mm (25mmL)
		3mm (75mmL); 3.5mm (100mmL);
	6pc	4mm (100mmL); 5.5mm (125mmL);
		6.5mm (150mmL); 8mm (175mmL)
	1pc	Locking pliers 10"(250mm) (614250)

DB2 (10523-131)



	14pc	6; 7; 8; 9; 10; 11; 12; 13; 14; 15; 16; 17; 18; 19 mm
	9pc	1/4"; 5/16"; 3/8"; 7/16"; 1/2"; 9/16"; 5/8"; 11/16"; 3/4"
	1pc	Waterpump pliers 10"(250mm) (613250)

DB3 (10523-131)



	1pc	610B200 Long nose pliers 8"(200mm)
	1pc	611B175 Combination pliers 7"(175mm)
	1pc	612B175 Diagonal pliers 7"(175mm)
	1pc	649200 Adjustable gauged wrench 8"(200mm)
	1pc	649300 Adjustable gauged wrench 12"(300mm)
	1pc	68021 Electrician folding knife

Glory red & black 6-drawer top chest with 227pc tools (S&M)



10526-227 1/41/44/4.8'

DT		
DL1	DC1	DRI
DB1		
DB2		
DB3		



DT



DL1



DC1

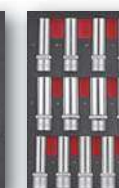

DRI



DB1



DB2



DB3

DT (10526-227)



	1pc	60212150 Chisel 12 (150mmL)
	1pc	60219200 Chisel 19 (200mmL)
	1pc	6042140 Pin punch 2 (140mmL) (€50613)
	1pc	6043150 Pin punch 3 (150mmL) (€50613)
	1pc	6044190 Pin punch 4 (190mmL) (€50613)
	1pc	6045200 Pin punch 5 (200mmL) (€50613)
	1pc	6046210 Pin punch 6 (210mmL) (€50613)
	1pc	6048215 Pin punch 8 (215mmL) (€50613)
	1pc	6074185 Center punch 4 (185mmL)
	1pc	613250 Waterpump pliers 10"(250mm)
	1pc	614250 Locking pliers 10"(250mm)
	1pc	616B16 Ball peen hammer 16oz. (350mmL)
	1pc	649200 Adjustable gauged wrench 8"(200mm)
	1pc	649300 Adjustable gauged wrench 12"(300mm)

DL1 (10526-227)



	9pc	1.5; 2; 2.5; 3; 4; 5; 6; 8; 10 mm (5093XLB)
	9pc	1/16"; 5/64"; 3/32"; 1/8"; 5/32"; 3/16"; 1/4"; 5/16"; 3/8" (5093XLBS)

DC1 (10526-227)



	9pc	T10; T15; T20; T25; T27; T30; T40; T45; T50 (5098XL)
	9pc	T-10H; T-15H; T-20H; T-25H; T-27H; T-30H; T-40H; T-45H; T-50H (5098XLT)

DR1 (10526-227)

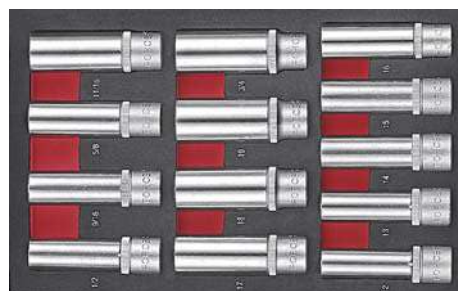

	8pc	1/2"DR. 12; 13; 14; 15; 16; 17; 18; 19 mm (77mmL)
	5pc	1/2"DR. 1/2"; 9/16"; 5/8"; 11/16"; 3/4" (77mmL)

DB1 (10526-227)



	1pc	PH.2 (25mmL)
	2pc	PH.1 (80mmL); PH.2 (100mmL)
	1pc	6.5mm (25mmL)
		3mm (75mmL); 3.5mm (100mmL);
	6pc	4mm (100mmL); 5.5mm (125mmL); 6.5mm (150mmL); 8mm (175mmL)
	1pc	Long nose pliers 8"(200mm) (610B200)
	1pc	Combination pliers 7"(175mm) (611B175)
	1pc	Diagonal pliers 7"(175mm) (612B175)
	1pc	Demagnetizer / Magnetizer (88601)

DB2 (10526-227)



	19pc	6; 7; 8; 9; 10; 11; 12; 13; 14; 15; 16; 17; 18; 19; 20; 21; 22; 23; 24 mm
	12pc	1/4"; 5/16"; 3/8"; 7/16"; 1/2"; 9/16"; 5/8"; 11/16"; 3/4"; 13/16"; 7/8"; 15/16"

DB3 (10526-227)

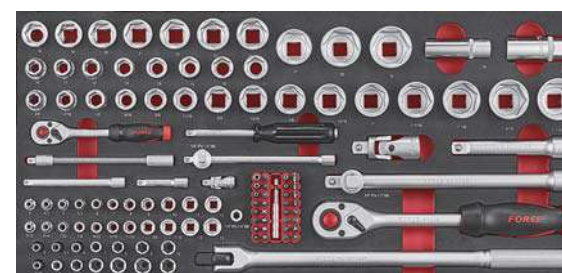

1/4"DR. Part		
	12pc	4; 4.5; 5; 5.5; 6; 7; 8; 9; 10; 11; 12; 13 mm
	10pc	5/32"; 3/16"; 7/32"; 1/4"; 9/32"; 5/16"; 11/32"; 3/8"; 7/16"; 1/2"
	9pc	5; 5.5; 6; 7; 8; 9; 10; 11; 12 mm (50mmL)
	5pc	3/16"; 1/4"; 5/16"; 3/8"; 7/16" (50mmL)
	1pc	QR pear ratchet handle 72teeth (80228)
	3pc	2"(50mm); 4"(100mm); 6"(150mm)
	1pc	1/4"
	1pc	3/8"(F)x1/4"(M) for extension
	1pc	1/4"DR.x1/4"(F)
	1pc	Flexible extension 5.8"(145mm)
	1pc	6"(150mm) with 1/4"DR.(F)

Bits (2331A)

	6pc	1/4" 2; 4; 6; 8; 10 mm; 1/4" (25mmL)
	4pc	1/4" 1; 2; 3; 4 (25mmL)
	6pc	1/4" 4; 6; 8; 10; 12; 14 mm (25mmL)
	4pc	1/4" No.0; No.1; No.2; No.3 (25mmL)
	6pc	1/4" 2; 2.5; 3; 4; 5; 6 mm (25mmL)
	6pc	1/4" 5/64"; 3/32"; 7/64"; 1/8"; 9/64"; 5/32" (25mmL)
	1pc	Magnetic 1/4"Hex-1/4"Hex 2.3"(60mm)

1/2"DR. Part

	18pc	10; 11; 12; 13; 14; 15; 16; 17; 18; 19; 20; 21; 22; 23; 24; 27; 30; 32 mm
	15pc	3/8"; 7/16"; 1/2"; 9/16"; 5/8"; 11/16"; 3/4"; 13/16"; 7/8"; 15/16"; 1"; 1-1/16"; 1-1/8"; 1-3/16"; 1-1/4"
	2pc	Spark plug 16mm (5/8"); 20.6mm (13/16")
	1pc	QR pear ratchet handle 72teeth (80248)
	1pc	15"(380mm)
	2pc	5"(125mm); 10"(250mm)
	1pc	1/2"
	1pc	3/8"(F)x1/2"(M) for extension

Glory red & black 9-drawer top chest with 303pc tools (S&M)



10529-303 1/52.4/55.4/4.8'

DT		
DL1	DC1	DR1
DL2	DC2	DR2
DB1		
DB2		
DB3		



DT DL1 DC1 DR1



DL2 DC2 DR2 DB1



DB2 DB3

DT (10529-303)



	1pc	PH.2 (25mmL)
	3pc	PH.1 (80mmL); PH.2 (100mmL); PH.3 (150mmL)
	1pc	6.5mm (25mmL)
	6pc	3mm (75mmL); 3.5mm (100mmL); 4mm (100mmL); 5.5mm (125mmL); 6.5mm (150mmL); 8mm (175mmL)
	1pc	Chisel 12 (150mmL) (60212150)
	1pc	Chisel 19 (200mmL) (60219200)
	6pc	Pin punch 2 (140mmL); 3 (150mmL); 4 (190mmL); 5 (200mmL); 6 (210mmL); 8 (215mmL) (50613)
	1pc	Center punch 4 (185mmL) (6074185)
	1pc	Waterpump pliers 10"(250mm) (613250)
	1pc	Locking pliers 10"(250mm) (614250)
	1pc	Ball peen hammer 16oz. (350mmL) (616B16)
	1pc	Adjustable gauged wrench 8"(200mm) (649200)
	1pc	Adjustable gauged wrench 12"(300mm) (649300)

DL1 (10529-303)

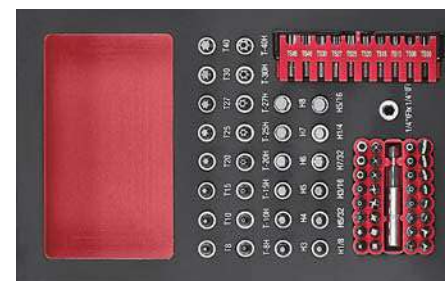

1/4"DR. Part		
	6pc	3; 4; 5; 6; 7; 8 mm (32mmL)
	6pc	1/8"; 5/32"; 3/16"; 7/32"; 1/4"; 5/16" (32mmL)
	8pc	T8; T10; T15; T20; T25; T27; T30; T40 (32mmL)
	8pc	T-8H; T-10H; T-15H; T-20H; T-25H; T-27H; T-30H; T-40H (32mmL)
	1pc	1/4"DR.x1/4"(F)

Bits		
	6pc	1/4" 2; 4; 6; 8; 10 mm; 1/4" (25mmL) (C2331A)
	4pc	1/4" 1; 2; 3; 4 (25mmL) (C2331A)
	6pc	1/4" 4; 6; 8; 10; 12; 14 mm (25mmL) (C2331A)
	4pc	1/4" No.0; No.1; No.2; No.3 (25mmL) (C2331A)
	6pc	1/4" 2; 2.5; 3; 4; 5; 6 mm (25mmL) (C2331A)
	6pc	1/4" 5/64"; 3/32"; 7/64"; 1/8"; 9/64"; 5/32" (25mmL) (C2331A)
	1pc	Magnetic 1/4"Hex-1/4"Hex 2.3"(60mm) (E2331A)
	10pc	1/4" TS8; TS10; TS15; TS20; TS25; TS27; TS30; TS40; TS45; TS50 (25mmL) (21013)

DC1 (10529-303)

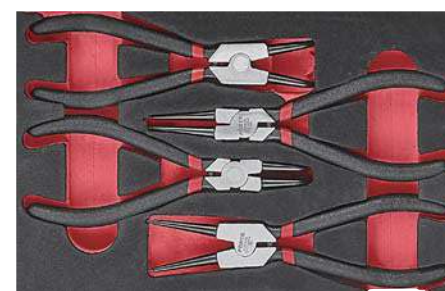

	1pc	609ABC Snap ring pliers (bent-close) 7"(180mm)
	1pc	609ABO Snap ring pliers (bent-open) 7"(180mm)
	1pc	609ASC Snap ring pliers (straight-close) 7"(180mm)
	1pc	609ASO Snap ring pliers (straight-open) 7"(180mm)

DR1 (10529-303)



	1pc	610B200 Long nose pliers 8"(200mm)
	1pc	611B175 Combination pliers 7"(175mm)
	1pc	612B175 Diagonal pliers 7"(175mm)

DL2 (10529-303)



	9pc	1.5; 2; 2.5; 3; 4; 5; 6; 8; 10 mm (5093XLB)
	9pc	1/16"; 5/64"; 3/32"; 1/8"; 5/32"; 3/16"; 1/4"; 5/16"; 3/8" (5093XLBS)

DC2 (10529-303)



	6pc	8x10; 11x13; 12x14; 16x18; 17x19; 19x22 mm
--	-----	--

DR2 (10529-303)



	5pc	5/16"x3/8"; 7/16"x1/2"; 1/2"x9/16"; 5/8"x3/4"; 3/4"x7/8"
--	-----	--

DB1 (10529-303)



	19pc	6; 7; 8; 9; 10; 11; 12; 13; 14; 15; 16; 17; 18; 19; 20; 21; 22; 23; 24 mm
	12pc	1/4"; 5/16"; 3/8"; 7/16"; 1/2"; 9/16"; 5/8"; 11/16"; 3/4"; 13/16"; 7/8"; 15/16"

DB2 (10529-303)



	12pc	4; 4.5; 5; 5.5; 6; 7; 8; 9; 10; 11; 12; 13 mm
	10pc	5/32"; 3/16"; 7/32"; 1/4"; 9/32"; 5/16"; 11/32"; 3/8"; 7/16"; 1/2"
	1pc	QR pear ratchet handle 72teeth (80228)
	3pc	2"(50mm); 4"(100mm); 6"(150mm)
	1pc	1/4"
	1pc	3/8"(F)x1/4"(M) for extension
	1pc	Flexible extension 5.8"(145mm)
	1pc	6"(150mm) with 1/4"DR.(F)

	15pc	8; 9; 10; 11; 12; 13; 14; 15; 16; 17; 18; 19; 20; 21; 22 mm
	7pc	3/8"; 7/16"; 1/2"; 9/16"; 5/8"; 11/16"; 3/4"
	11pc	8; 10; 11; 12; 13; 14; 15; 16; 17; 18; 19 mm (63mmL)
	8pc	5/16"; 3/8"; 7/16"; 1/2"; 9/16"; 5/8"; 11/16"; 3/4" (63mmL)
	1pc	20-110 Nm, 365mmL (6473365)
	1pc	QR pear ratchet handle 72teeth (80238)
	1pc	Bent 8"(200mm)
	2pc	3"(75mm); 6"(150mm)
	1pc	3/8"
	1pc	1/2"(F)x3/8"(M) for extension

DB3 (10529-303)



	18pc	10; 11; 12; 13; 14; 15; 16; 17; 18; 19; 20; 21; 22; 23; 24; 27; 30; 32 mm
	15pc	3/8"; 7/16"; 1/2"; 9/16"; 5/8"; 11/16"; 3/4"; 13/16"; 7/8"; 15/16"; 1"; 1-1/16"; 1-1/8"; 1-3/16"; 1-1/4"
	3pc	21; 22; 24 mm (77mmL)
	3pc	13/16"; 7/8"; 15/16" (77mmL)
	2pc	Spark plug 16mm (5/8"); 20.6mm (13/16")
	2pc	10; 12 mm (55mmL)
	1pc	14 mm (65mmL)
	1pc	17 mm (70mmL)
	3pc	3/8"; 7/16"; 1/2" (55mmL)
	2pc	9/16"; 5/8" (65mmL)
	5pc	T40; T45; T50; T55; T60 (55mmL)
	1pc	QR pear ratchet handle 72teeth (80248)
	1pc	15"(380mm)
	2pc	5"(125mm); 10"(250mm)
	1pc	1/2"
	1pc	3/8"(F)x1/2"(M) for extension

Glory red & black 10-drawer top chest with 297pc tools (S&M)



1052D-297 1/64.3/66.3/7"

DT		
DL1	DC1	DR1
DL2		DR2
DL3		DR3
DB1		
DB2		
DB3		



DT



DR2



DL3



DR3

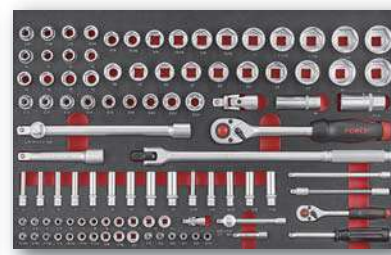

DB1



DB2

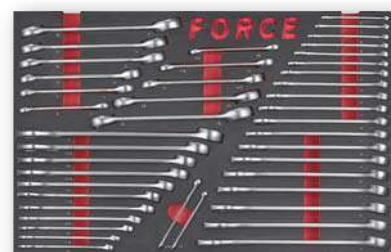

DB3

DT (1052D-297)



	1pc	60212150	Chisel 12 (150mmL)
	1pc	60219200	Chisel 19 (200mmL)
	1pc	6042140	Pin punch 2 (140mmL) (€ 50613)
	1pc	6043150	Pin punch 3 (150mmL) (€ 50613)
	1pc	6044190	Pin punch 4 (190mmL) (€ 50613)
	1pc	6045200	Pin punch 5 (200mmL) (€ 50613)
	1pc	6046210	Pin punch 6 (210mmL) (€ 50613)
	1pc	6048215	Pin punch 8 (215mmL) (€ 50613)
	1pc	6074185	Center punch 4 (185mmL)
	1pc	610B200	Long nose pliers 8" (200mm)
	1pc	611B175	Combination pliers 7" (175mm)
	1pc	612B175	Diagonal pliers 7" (175mm)
	1pc	613250	Waterpump pliers 10" (250mm)
	1pc	616B16	Ball peen hammer 16oz. (350mmL)
	1pc	61802	Feeler gauges of 26 sizes (SAE&MM)
	1pc	649200	Adjustable gauged wrench 8" (200mm)
	1pc	649300	Adjustable gauged wrench 12" (300mm)

Screw extractor			
	1pc	9UXAM06	1/8"(M3) to 1/4"(M6) (€63005)
	1pc	9UXAM08	1/4"(M6) to 5/16"(M8) (€63005)
	1pc	9UXAM11	5/16"(M8) to 7/16"(M11) (€63005)
	1pc	9UXAM14	7/16"(M11) to 9/16"(M14) (€63005)
	1pc	9UXAM18	9/16"(M14) to 3/4"(M18) (€63005)

DR2 (1052D-297)



Bits			
	6pc	1/4" 2; 4; 6; 8; 10 mm; 1/4" (25mmL)	(C2331A)
	4pc	1/4" 1; 2; 3; 4 (25mmL)	(C2331A)
	6pc	1/4" 4; 6; 8; 10; 12; 14 mm (25mmL)	(C2331A)
	4pc	1/4" No.0; No.1; No.2; No.3 (25mmL)	(C2331A)
	6pc	1/4" 2; 2.5; 3; 4; 5; 6 mm (25mmL)	(C2331A)
	6pc	1/4" 5/64"; 3/32"; 7/64"; 1/8"; 9/64"; 5/32" (25mmL)	(C2331A)
	1pc	Magnetic 1/4"Hex-1/4"Hex 2.3"(60mm)	(€2331A)
	10pc	1/4" TS8; TS10; TS15; TS20; TS25; TS27; TS30; TS40; TS45; TS50 (25mmL)	(21013)

1/4"DR. Part			
	6pc	3; 4; 5; 6; 7; 8 mm (32mmL)	
	6pc	1/8"; 5/32"; 3/16"; 7/32"; 1/4"; 5/16" (32mmL)	
	8pc	T8; T10; T15; T20; T25; T27; T30; T40 (32mmL)	
	8pc	T-8H; T-10H; T-15H; T-20H; T-25H; T-27H; T-30H; T-40H (32mmL)	
	1pc	1/4"DR.x1/4"(F)	

1/2"DR. Part			
	4pc	10; 12 mm (55mmL)	
	4pc	14 mm (65mmL)	
	5pc	17 mm (70mmL)	
	5pc	3/8"; 7/16"; 1/2" (55mmL)	
	5pc	9/16"; 5/8" (65mmL)	
	5pc	T40; T45; T50; T55; T60 (55mmL)	

DL3 (1052D-297)



	10pc	3/8"; 7/16"; 1/2"; 9/16"; 5/8"; 11/16"; 3/4"; 13/16"; 7/8"; 15/16" (85mmL)
--	------	--

DR3 (1052D-297)



	11pc	12; 13; 14; 15; 16; 17; 18; 19; 21; 22; 24 mm (85mmL)
--	------	---

DB1 (1052D-297)

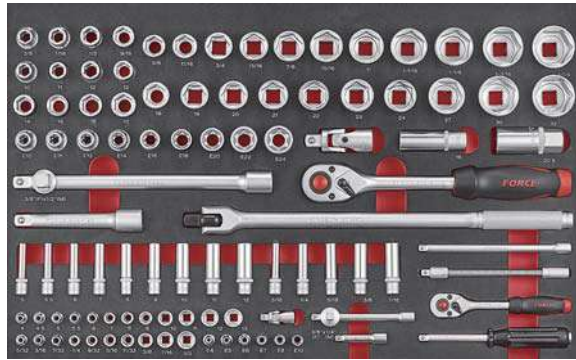

1/4"DR. Part

	12pc	4; 4.5; 5; 5.5; 6; 7; 8; 9; 10; 11; 12; 13 mm
	10pc	5/32"; 3/16"; 7/32"; 1/4"; 9/32"; 5/16"; 11/32"; 3/8"; 7/16"; 1/2"
	9pc	5; 5.5; 6; 7; 8; 9; 10; 11; 12 mm (50mmL)
	5pc	3/16"; 1/4"; 5/16"; 3/8"; 7/16" (50mmL)
	6pc	E4; E5; E6; E7; E8; E10
	1pc	QR pear ratchet handle 72teeth (80228)
	3pc	2"(50mm); 4"(100mm); 6"(150mm)
	1pc	1/4"
	1pc	3/8"(F)x1/4"(M) for extension
	1pc	Flexible extension 5.8"(145mm)
	1pc	6"(150mm) with 1/4"DR.(F)

1/2"DR. Part

	18pc	10; 11; 12; 13; 14; 15; 16; 17; 18; 19; 20; 21; 22; 23; 24; 27; 30; 32 mm
	15pc	3/8"; 7/16"; 1/2"; 9/16"; 5/8"; 11/16"; 3/4"; 13/16"; 7/8"; 15/16"; 1"; 1-1/16"; 1-1/8"; 1-3/16"; 1-1/4"
	9pc	E10; E11; E12; E14; E16; E18; E20; E22; E24
	2pc	Spark plug 16mm (5/8"); 20.6mm (13/16")
	1pc	QR pear ratchet handle 72teeth (80248)
	1pc	15"(380mm)
	2pc	5"(125mm); 10"(250mm)
	1pc	1/2"
	1pc	3/8"(F)x1/2"(M) for extension

DB2 (1052D-297)



	1pc	PH.2 (25mmL)
	4pc	PH.0 (60mmL); PH.1 (80mmL); PH.2 (100mmL); PH.3 (150mmL)
	1pc	6.5mm (25mmL)
	6pc	3mm (75mmL); 3.5mm (100mmL); 4mm (100mmL); 5.5mm (125mmL); 6.5mm (150mmL); 8mm (175mmL)
	7pc	2.5; 3; 4; 5; 6; 7; 8 mm
	6pc	3/32"; 1/8"; 5/32"; 3/16"; 1/4"; 5/16"

DB3 (1052D-297)

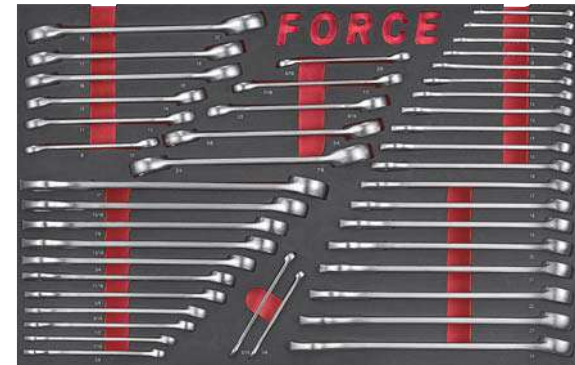

	6pc	8x10; 11x13; 12x14; 16x18; 17x19; 19x22 mm
	5pc	5/16"x3/8"; 7/16"x1/2"; 1/2"x9/16"; 5/8"x3/4"; 3/4"x7/8"
	19pc	6; 7; 8; 9; 10; 11; 12; 13; 14; 15; 16; 17; 18; 19; 20; 21; 22; 23; 24 mm
	13pc	1/4"; 5/16"; 3/8"; 7/16"; 1/2"; 9/16"; 5/8"; 11/16"; 3/4"; 13/16"; 7/8"; 15/16"; 1"

2-Drawer tool cabinet

50352  1/34.2/35.2/8.1'

- L65.5 x W28 x H81 cm
- 15 pcs hooks included.



2-Drawer tool cabinet with 129pc tools









50352-129

 1/46.8/48.8/9'







50352-129





1/4"DR. Part (C4234A+2421F)

	14pc	3.2; 4; 4.5; 5; 5.5; 6; 7; 8; 9; 10; 11; 12; 13; 14 mm
	1pc	QR flexible pear ratchet handle 20teeth (802218)
	2pc	2"(50mm); 6"(150mm)
	1pc	1/4"
	1pc	3/8"(F)x1/4"(M) for extension
	1pc	1/4"DR.x1/4"(F)
	1pc	Magnetic socket pick-up (25mmL)
	1pc	6"(150mm) with 1/4"DR.(F)



























1/2"DR. Part (C4234A+2421F)

	18pc	10; 11; 12; 13; 14; 15; 16; 17; 18; 19; 20; 21; 22; 23; 24; 27; 30; 32 mm
	1pc	Round ratchet handle 72teeth (80249)
	2pc	5"(125mm); 10"(250mm)
	1pc	1/2"
	1pc	3/8"(F)x1/2"(M) for extension

Bits (C4234A+2421F)

	3pc	1/4" PH.1; PH.2; PH.3 (25mmL)
	3pc	1/4" PZ.1; PZ.2; PZ.3 (25mmL)
	3pc	1/4" 4; 5.5; 6.5 mm (25mmL)
	5pc	1/4" 3; 4; 5; 6; 8 mm (25mmL)
	6pc	1/4" T10; T15; T20; T25; T30; T40 (25mmL)

Others

	4pc	PH.0 (60mmL); PH.1 (80mmL); PH.2 (100mmL); PH.3 (150mmL)
	4pc	3mm (75mmL); 4mm (100mmL); 6.5mm (150mmL); 8mm (175mmL)
	7pc	2.5; 3; 4; 5; 6; 8; 10 mm (5072BF)
	8pc	T9; T10; T15; T20; T25; T27; T30; T40 (5083F)
	7pc	6; 7; 9; 20; 21; 23; 24 mm
	12pc	8; 10; 11; 12; 13; 14; 15; 16; 17; 18; 19; 22 mm (5123)
	1pc	5056P1 8"(200mm) Flat file
	1pc	5056P2 8"(200mm) Half-round file
	1pc	5056P3 8"(200mm) Round file
	1pc	5056P4 8"(200mm) Square file
	1pc	5056P5 8"(200mm) Triangular file
	1pc	5096A805 Auto-stop 5m measuring tape
	1pc	60212150 Chisel 12 (150mmL) (€ 5054)
	1pc	603150 Cape chisel (150mmL) (€ 5054)
	1pc	6044190 Pin punch 4 (190mmL) (€ 5054)
	1pc	6063185 Taper punch 3 (185mmL) (€ 5054)
	1pc	6074185 Center punch 4 (185mmL) (€ 5054)
	1pc	610B200 Long nose pliers 8"(200mm)
	1pc	611B175 Combination pliers 7"(175mm)
	1pc	612B160 Diagonal pliers 6.3"(160mm)
	1pc	613B250 Waterpump pliers 10"(250mm)
	1pc	614250 Locking pliers 10"(250mm)
	1pc	616300 Engineer hammer 300gw
	1pc	616A400 Soft face hammer 400gw
	1pc	649250A Adjustable gauged wrench 10"(250mm)
	1pc	66301 Super heavy duty hacksaw
	1pc	68021 Electrician folding knife
	1pc	6983 Technician's scissors

2-Drawer service cart

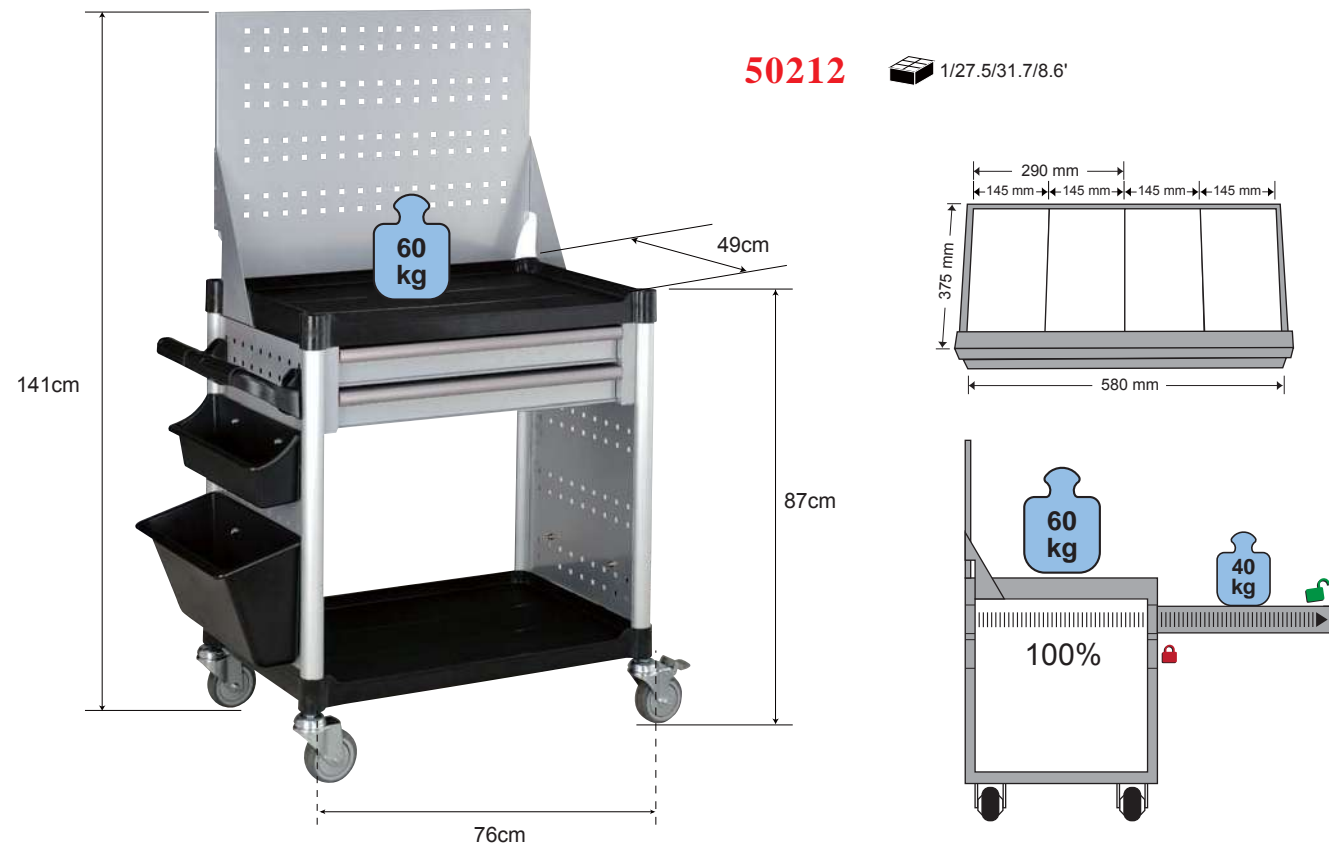

Heavy-duty workbench with drawers & fiberboard

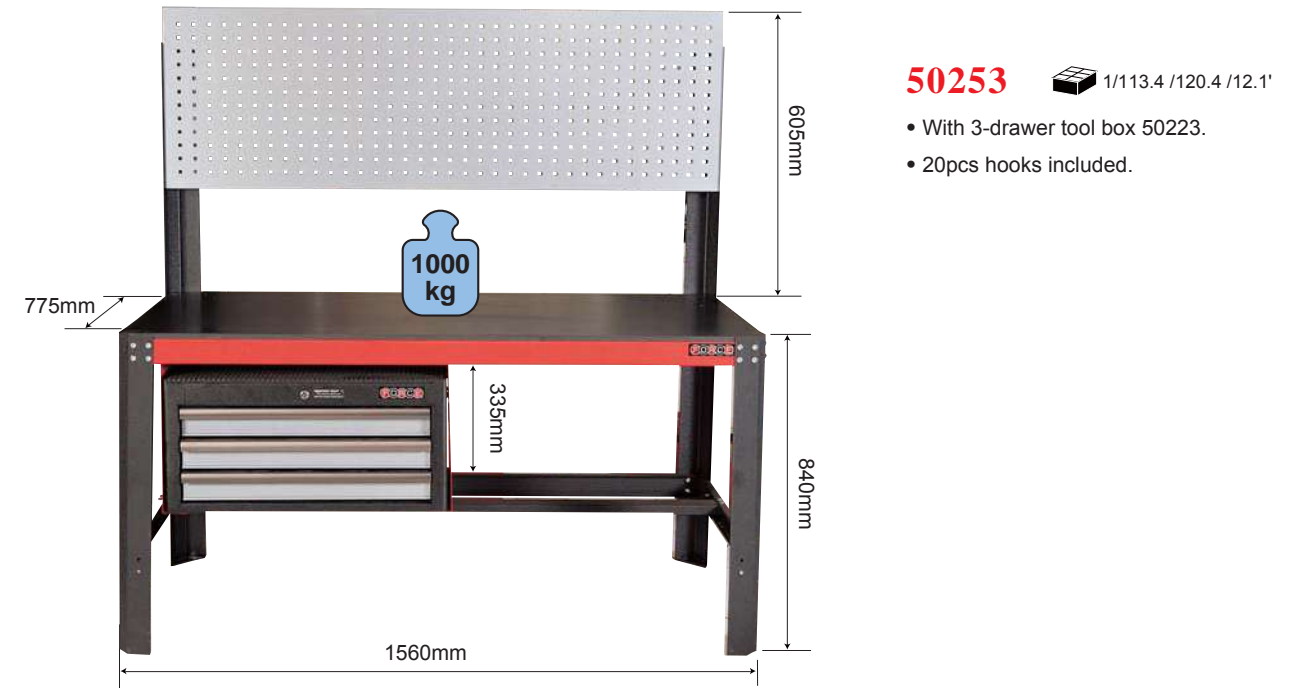

3-Drawer tool box



Heavy-duty workbench with drawers & lockable cabinet

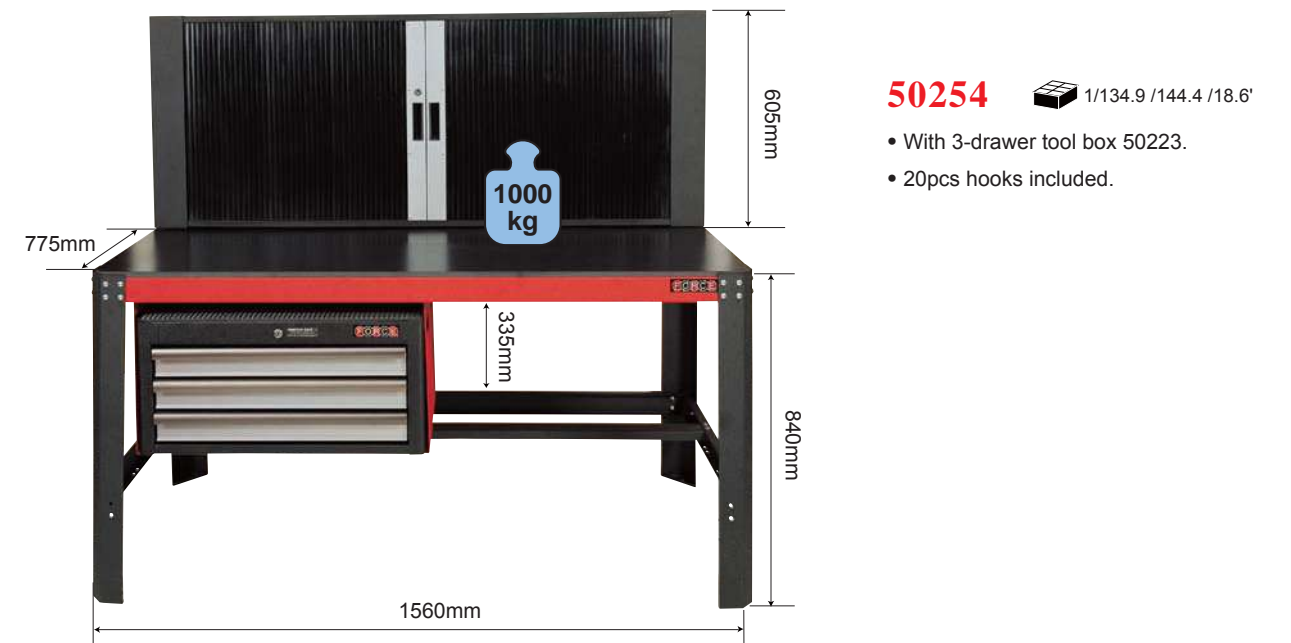

Heavy-duty workbench with 177pc tools



50253-177

1/138.6/146/12.1'

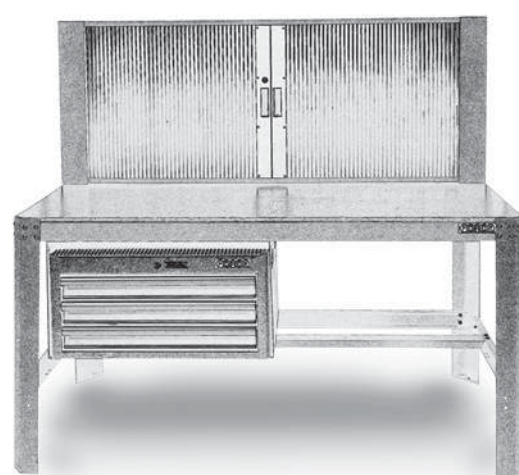

50254-177

1/169.6/177.5/18.6'

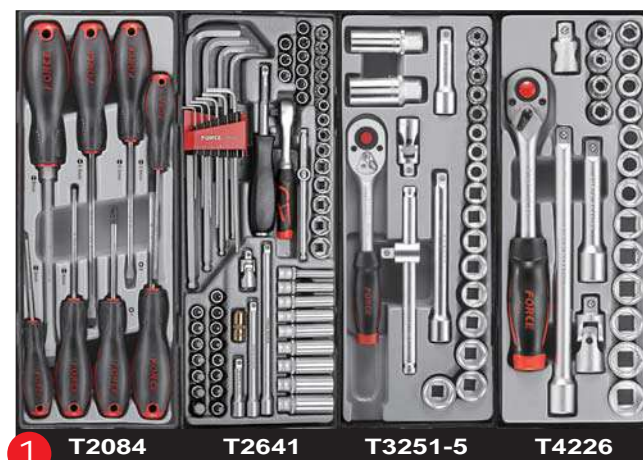

Accessories: hooks



- 82022D**
2" Double hooks + screws
- 82022DW**
2" Double hooks + screws
(span is 3cm)
- 82023S**
3" Single hook + screws
- 82023D**
3" Double hooks + screws
- 82023U**
3" U-shaped hook + screws

- 82026S**
6" Single hook + screws
- 82026D**
6" Double hooks + screws
- 82026U**
6" U-shaped hook + screws
- 82028U**
8" U-shaped hook + screws

•Applicable: 50352, 50212, 50253, 50254

Accessories: holders



10210H1
Socket holder



10210H2
Screwdriver holder



10210H3
Wrench holder



10210H4
T-handle tool holder

•Applicable: 10517, 10215, 10216, 10217, 10218, 10318 and their other color versions.

Basic 7-drawer trolley



10517



10517B

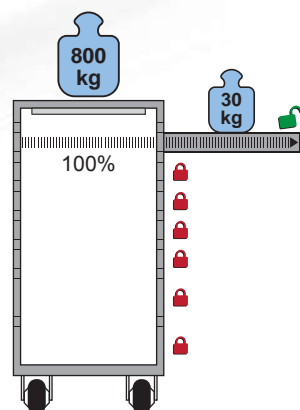
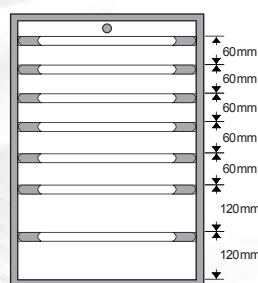
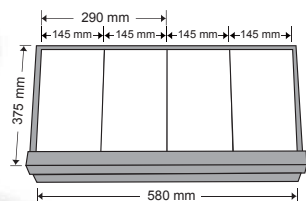

• L69 x W46.5 x H98 cm
 1/54/58.7/14.3'

285pcs Tools

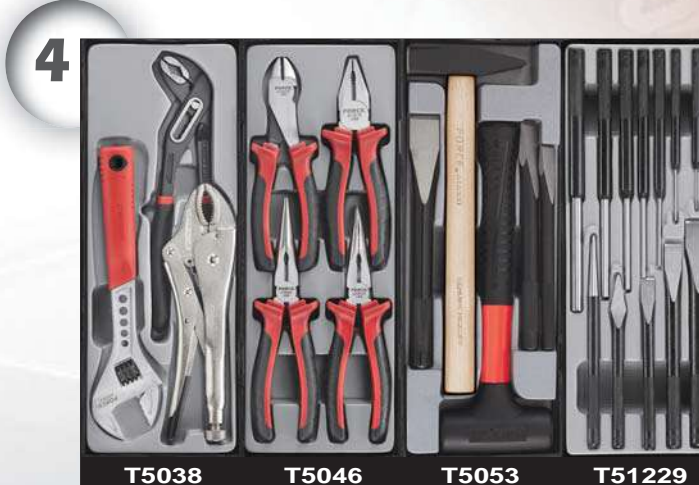
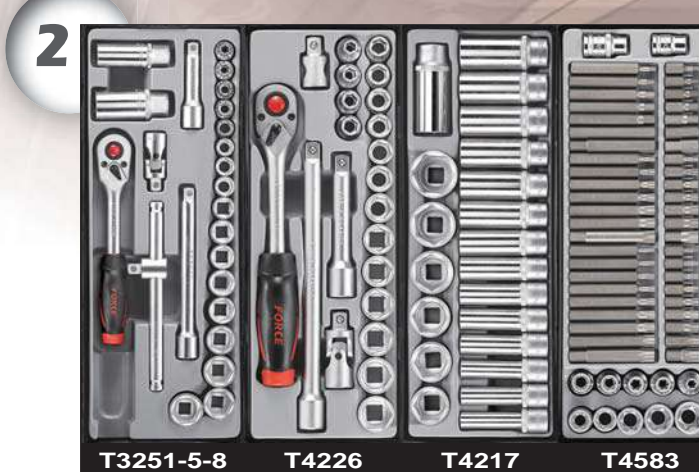

Optional Accessories



105106
 Plastic can holder
 42x10.5x12.5cm



105106L
 Plastic can holder(big)
 42x14.5x19cm



102104
 102104R
 102104B
 Side table



102105
 102105R
 102105B
 Paper holder



102102
 102102R
 102102B
 Side shelf



102101
 102101R
 102101B
 Side lock cabinet
 With 2pcs of 82022DW (2" double hooks)

10517-285

10517B-285

1/82.3/87/14.3'

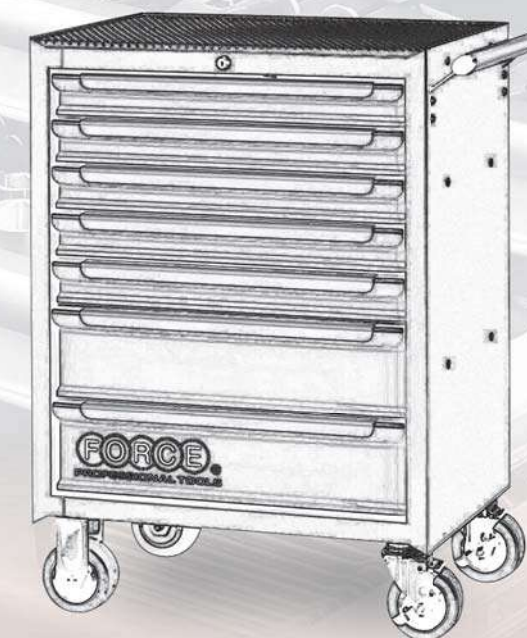

305pcs Tools

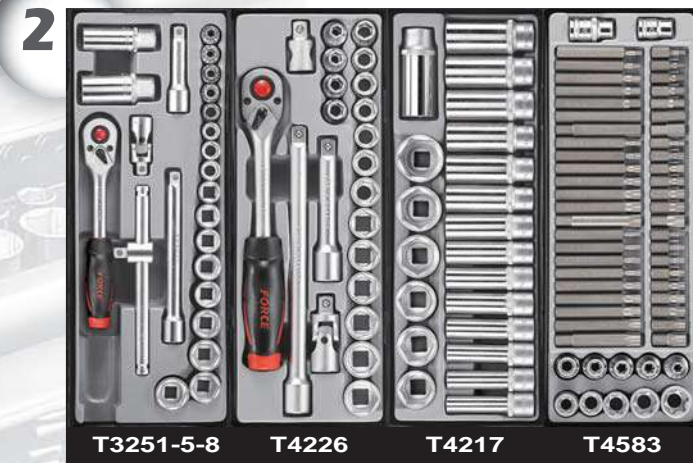

10517-305

10517B-305

1/87/91.7/14.3'

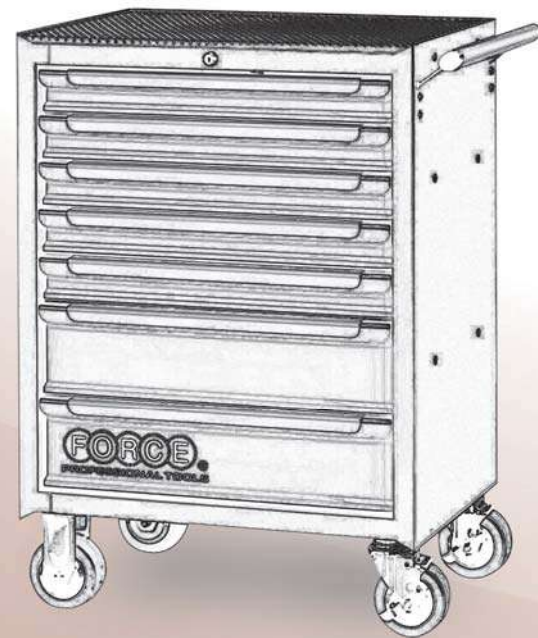

310pcs Tools

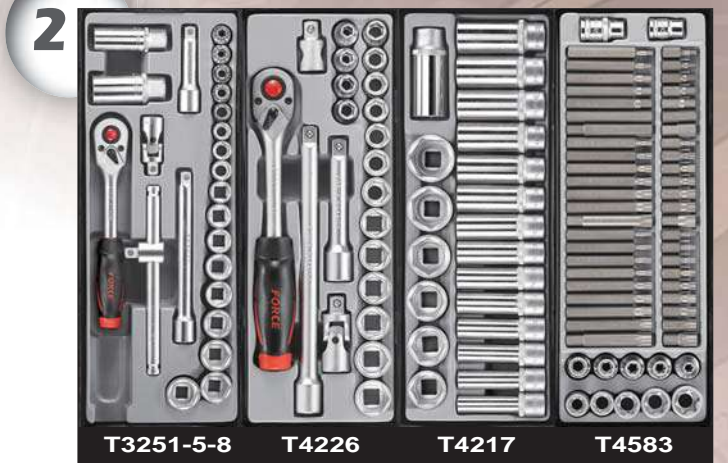
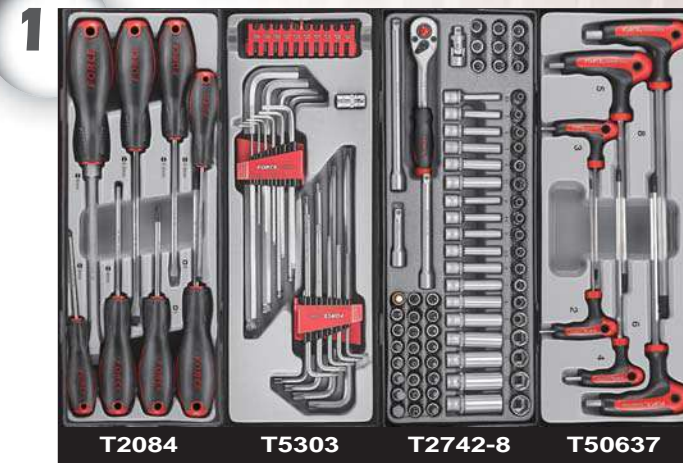

10517-310

10517B-310

1/83.1/87.8/14.3'



337pcs Tools

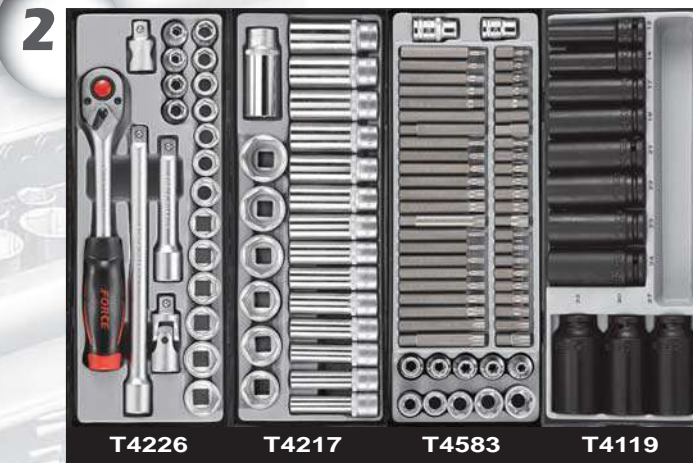
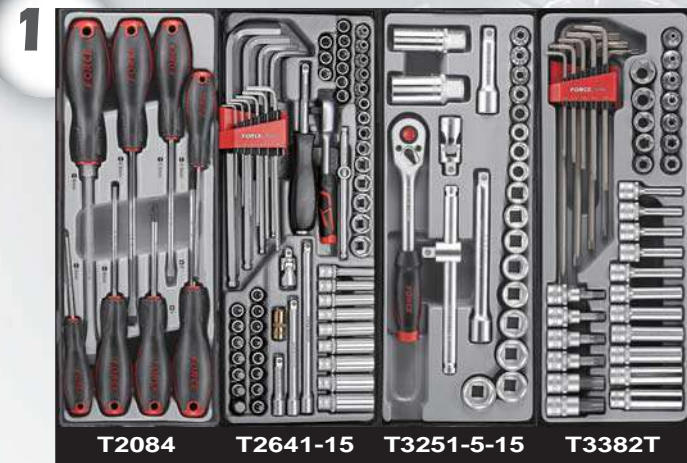

10517-337

10517B-337

1/95/99.7/14.3'

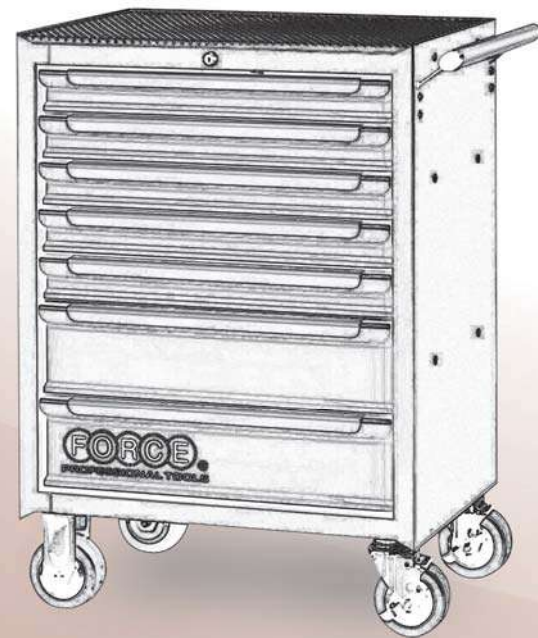

Practical series

Packaged Accessories

Optional Accessories



- Dual-material handle



- 102103P
Strong plastic top tray



- 102170LK
• Foldable key to prevent from breaking due to casual bumping



- Full screw track allows height adjustable



- 102106 ■ 102106R
■ 102106B ■ 102106A
Can holder



- Strong caster with brake
• Plastic corner for protection



- Plastic-under provides coldness isolation for hand



- 102104 ■ 102104R ■ 102104B
Side table



- 102105 ■ 102105R
■ 102105B
Paper holder



- 102102 ■ 102102R
■ 102102B
Side shelf



- 102170BBS
• Ball bearing slides
• Only one drawer openable at a time



- 102101 ■ 102101R
■ 102101B

Side lock cabinet
With 2pcs of 82022DW (2" double hooks)



Practical 5-drawer trolley



10215

10215B

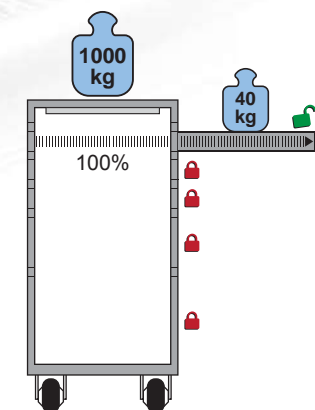

Practical 7-drawer trolley



10217

10217B

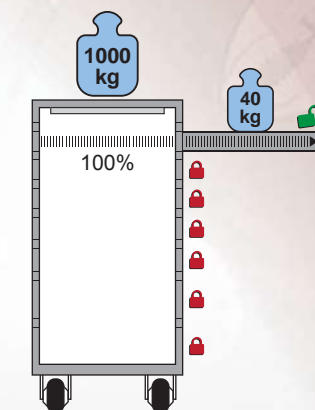

Practical 6-drawer trolley



10216

10216B

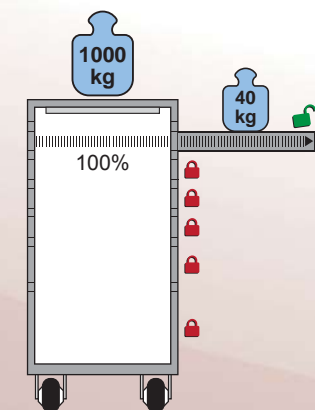

Practical 8-drawer trolley



10218

10218B

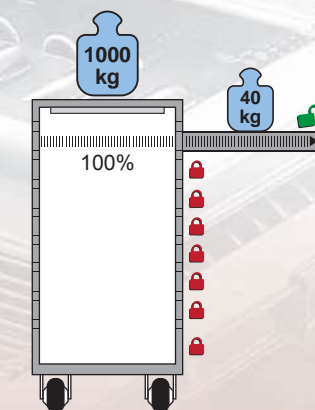

Practical 5-drawer tool box



10225



10225B

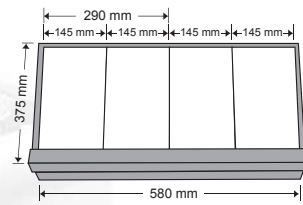

• L69 x W46 x H49 cm
1/38.7/41.9/8.9'



10225A



10225R

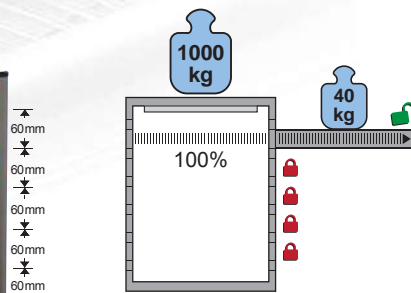

210pcs Tools

1

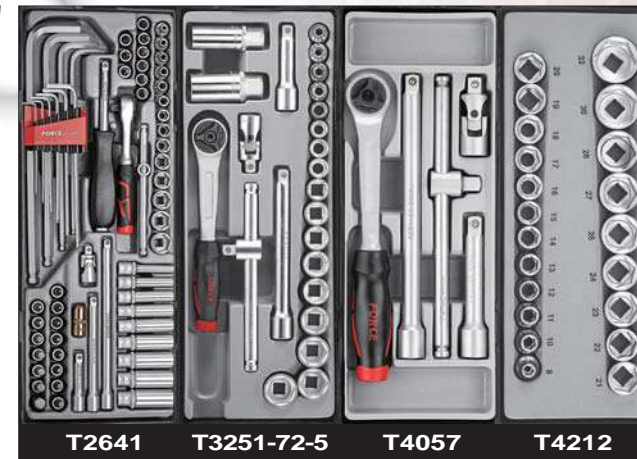

- 10215-210
- 10215B-210
- 10215R-210
- 10215A-210

1/83.7/89.2/14.8'

2

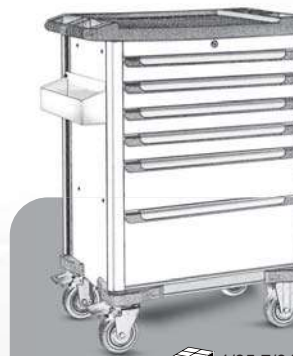

- 10216-210
- 10216B-210
- 10216R-210
- 10216A-210

1/85.7/91.2/14.8'

3

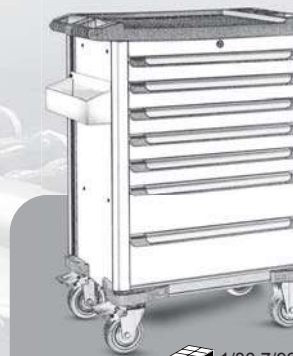

- 10217-210
- 10217B-210
- 10217R-210
- 10217A-210

1/86.7/92.2/14.8'

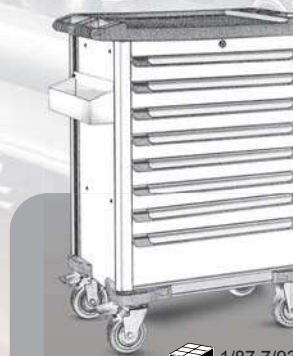

- 10218-210
- 10218B-210
- 10218R-210
- 10218A-210

1/87.7/93.2/14.8'

219pcs Tools

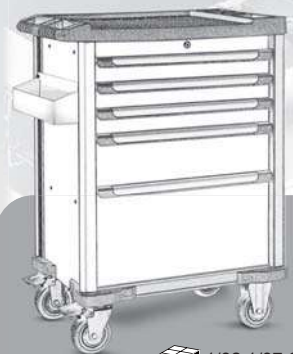

- 10215-219
- 10215B-219
- 10215R-219
- 10215A-219

1/82.1/87.6/14.8'

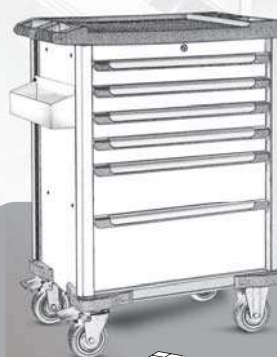

- 10216-219
- 10216B-219
- 10216R-219
- 10216A-219

1/84.7/90.2/14.8'

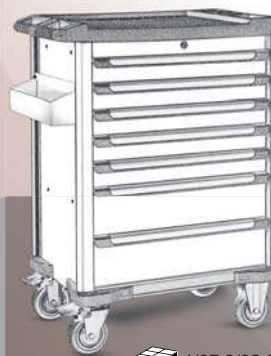

- 10217-219
- 10217B-219
- 10217R-219
- 10217A-219

1/87.3/92.8/14.8'

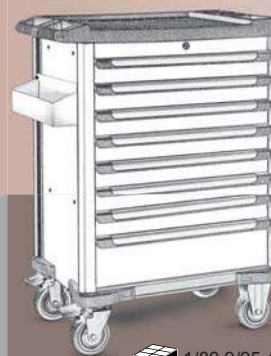

- 10218-219
- 10218B-219
- 10218R-219
- 10218A-219

1/89.9/95.4/14.8'

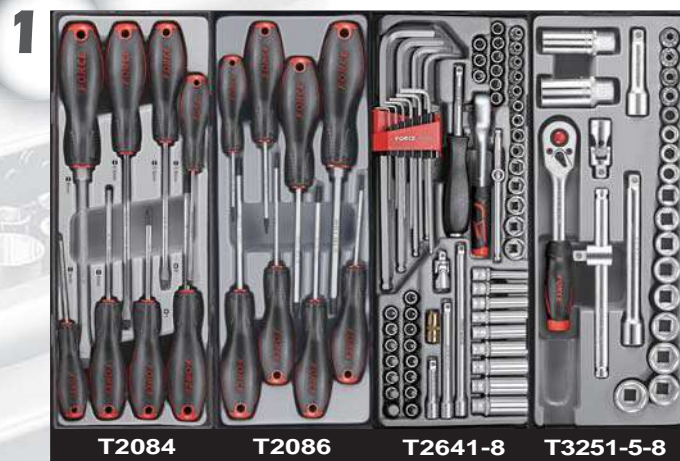

245pcs Tools

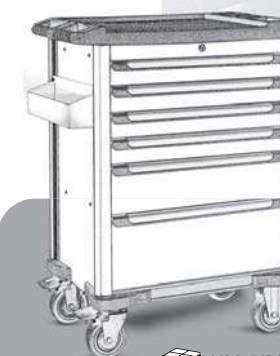
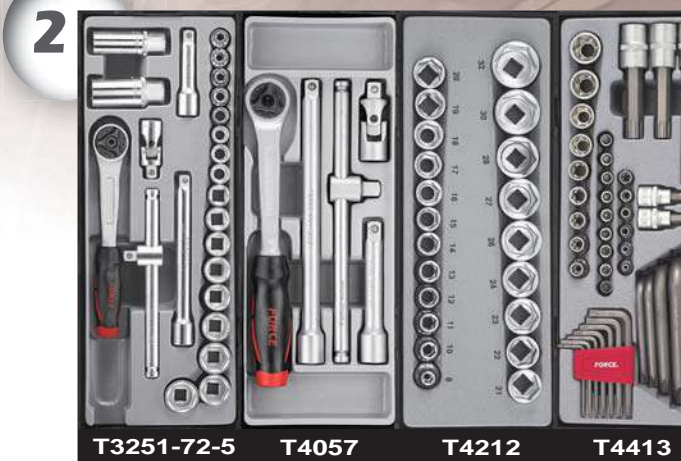
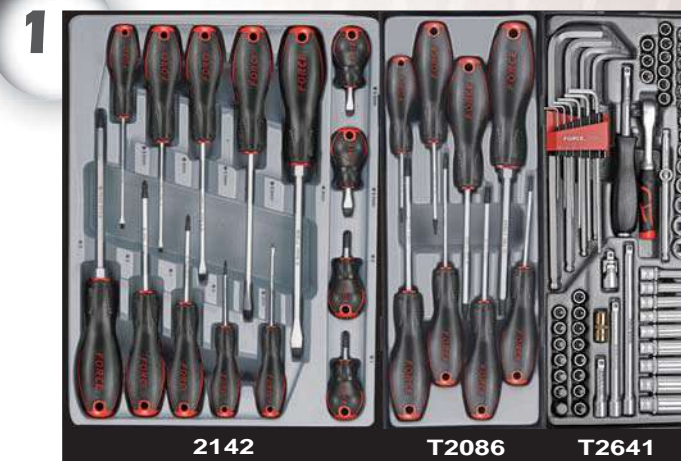

- 10216-245
- 10216B-245
- 10216R-245
- 10216A-245

1/90.5/96/14.8'



- 10217-245
- 10217B-245
- 10217R-245
- 10217A-245

1/91.9/97.4/14.8'

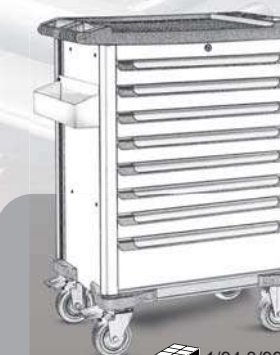

- 10218-245
- 10218B-245
- 10218R-245
- 10218A-245

1/94.3/99.8/14.8'

302pcs Tools

286pcs Tools

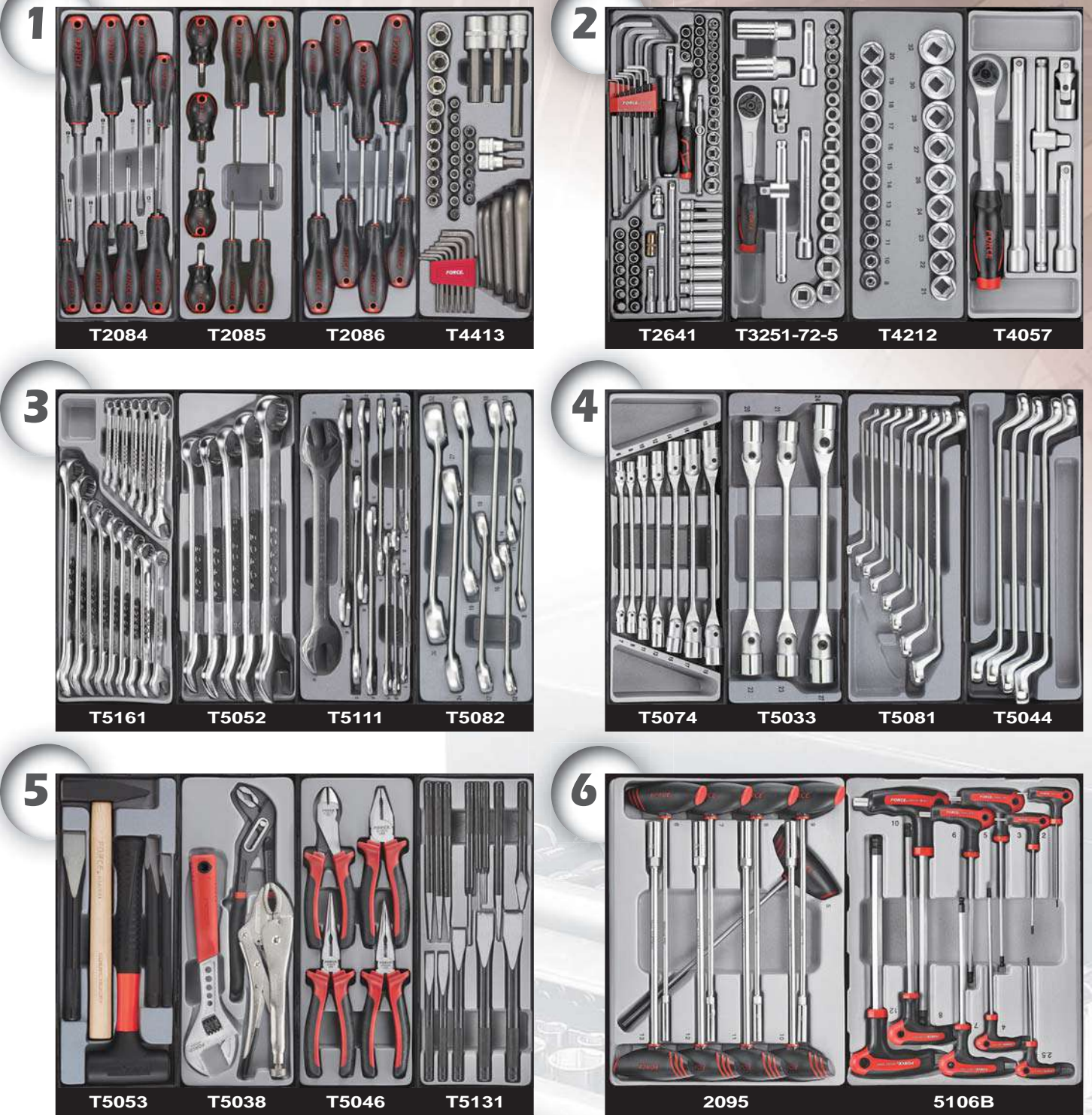
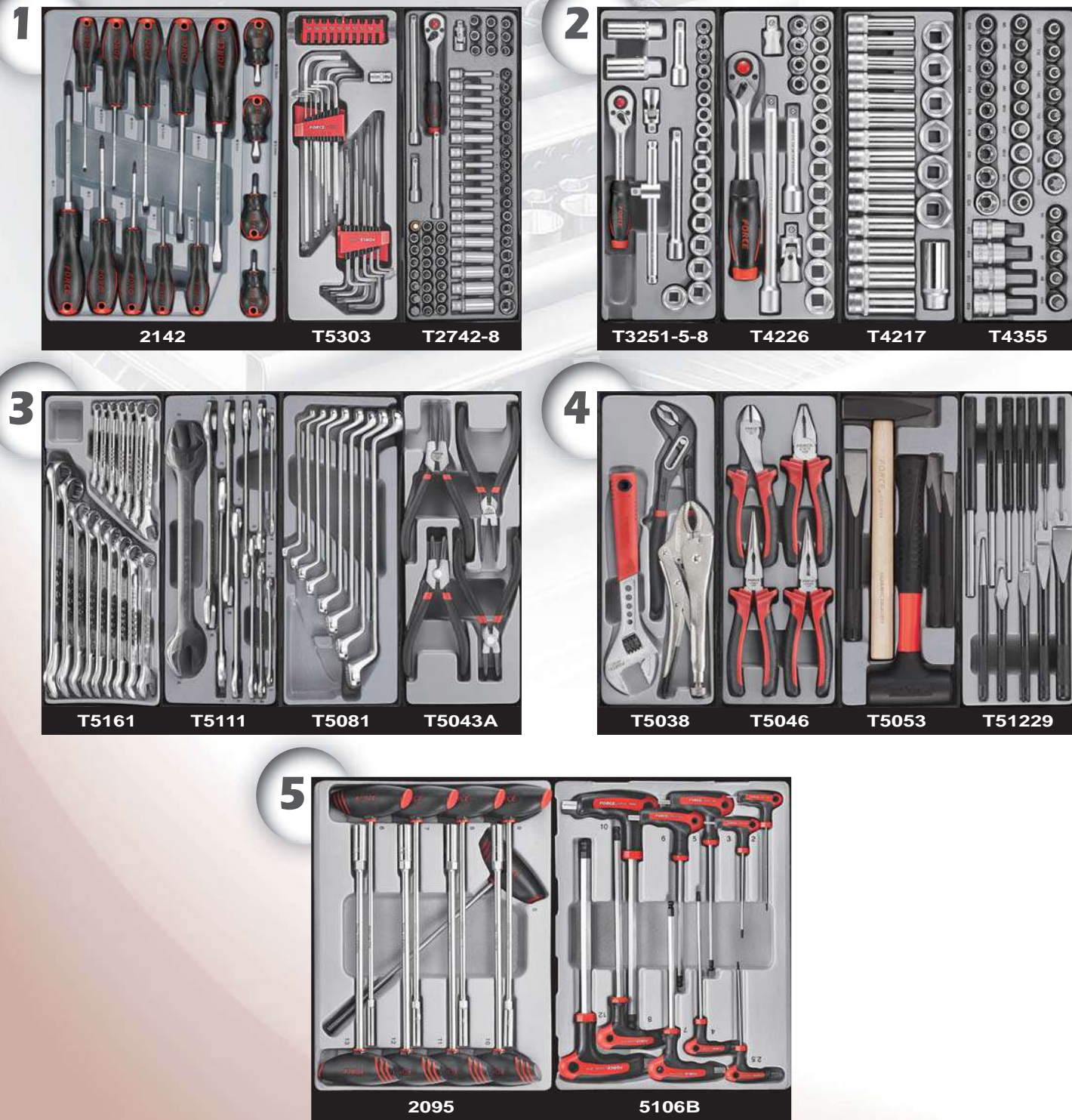

- 10217-302
- 10217B-302
- 10217R-302
- 10217A-302

1/102.9/108.4/14.8"

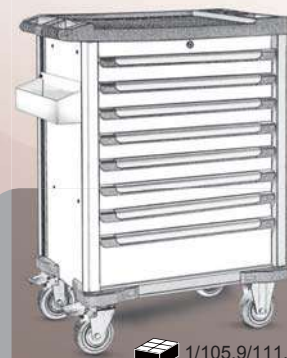

- 10218-302
- 10218B-302
- 10218R-302
- 10218A-302

1/105.9/111.4/14.8"

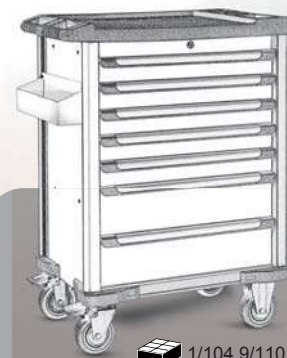

- 10217-286
- 10217B-286
- 10217R-286
- 10217A-286

1/104.9/110.4/14.8"

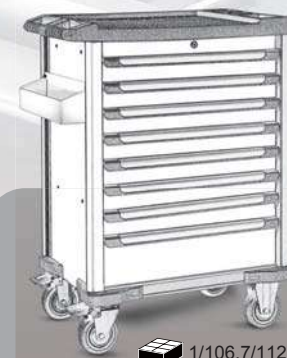

- 10218-286
- 10218B-286
- 10218R-286
- 10218A-286

1/106.7/112.2/14.8"

325pcs Tools (S&M)

361pcs Tools

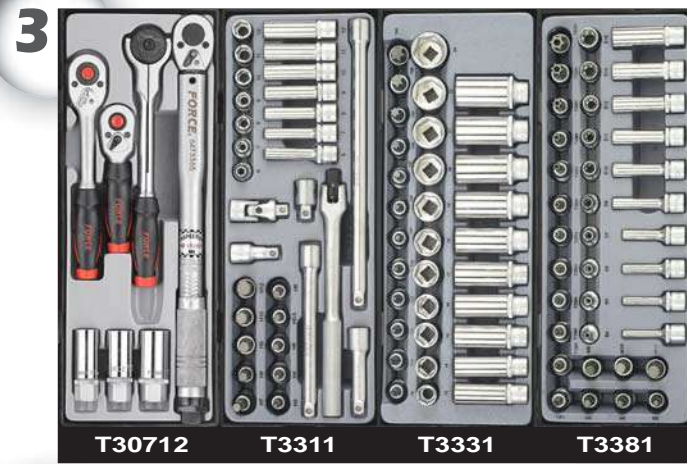
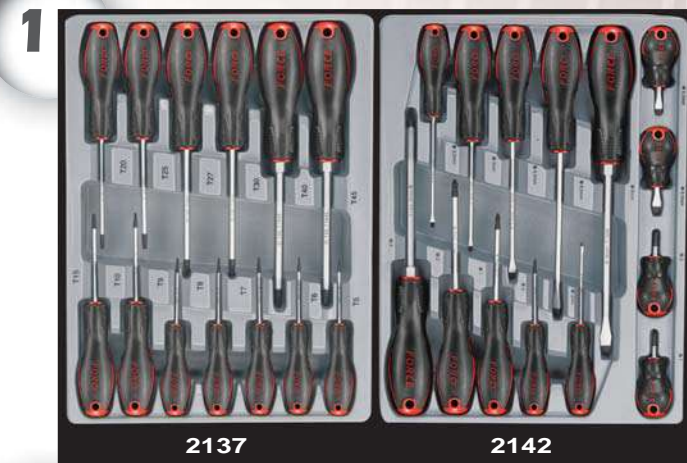
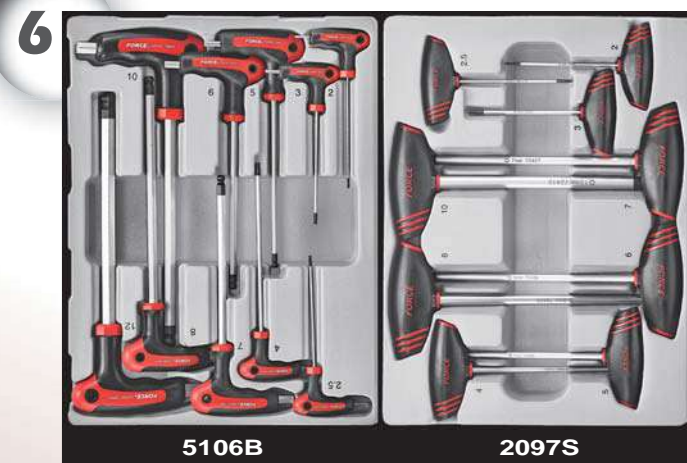

- 10217-325
- 10217B-325
- 10217R-325
- 10217A-325



- 10218-325
- 10218B-325
- 10218R-325
- 10218A-325

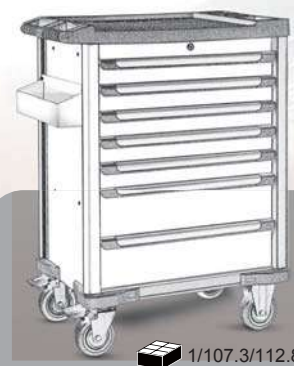

- 10217-361
- 10217B-361
- 10217R-361
- 10217A-361



- 10218-361
- 10218B-361
- 10218R-361
- 10218A-361

376pcs Tools

345pcs Tools

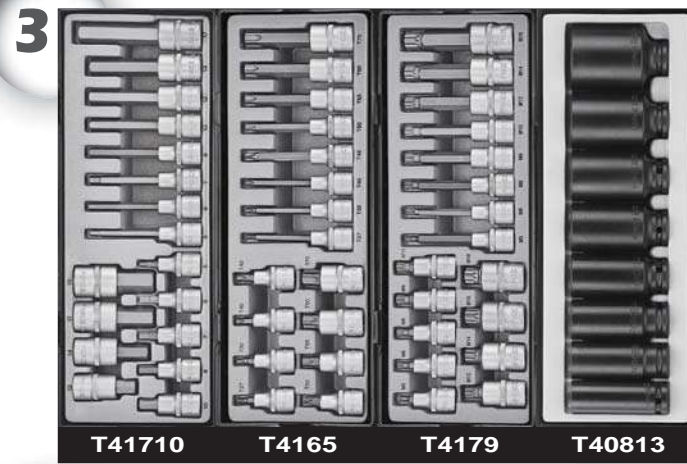
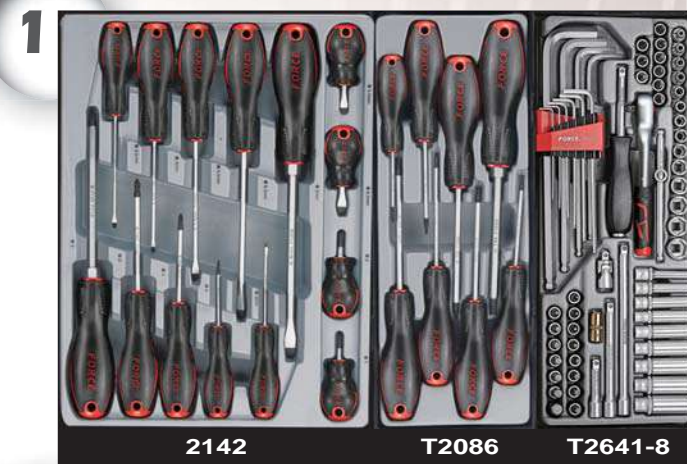
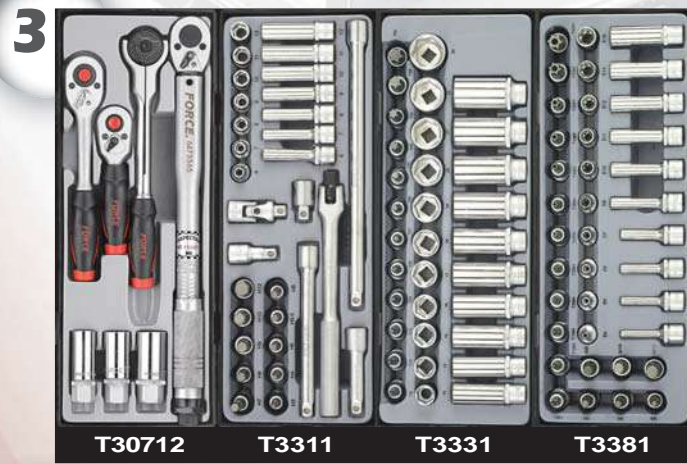
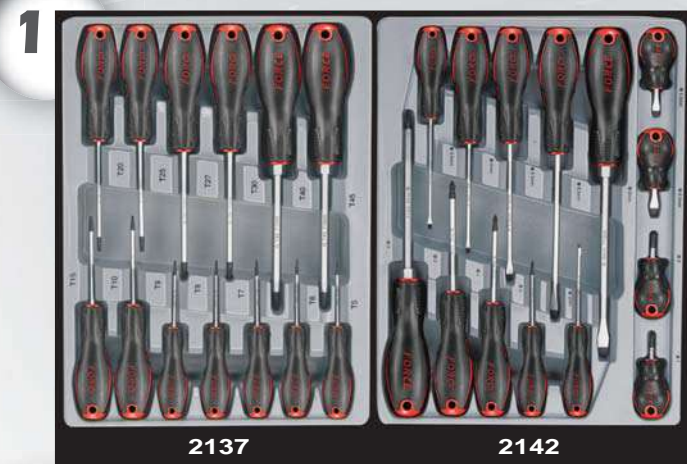

- 10217-376
- 10217B-376
- 10217R-376
- 10217A-376



- 10218-376
- 10218B-376
- 10218R-376
- 10218A-376



- 10217-345
- 10217B-345
- 10217R-345
- 10217A-345



- 10218-345
- 10218B-345
- 10218R-345
- 10218A-345

562pcs Tools

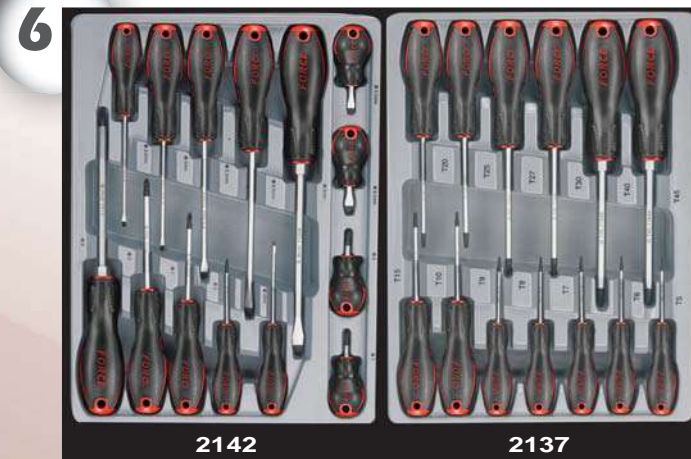
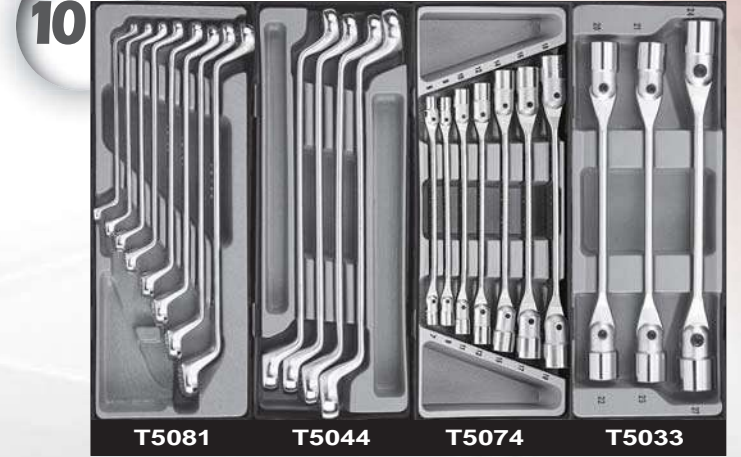
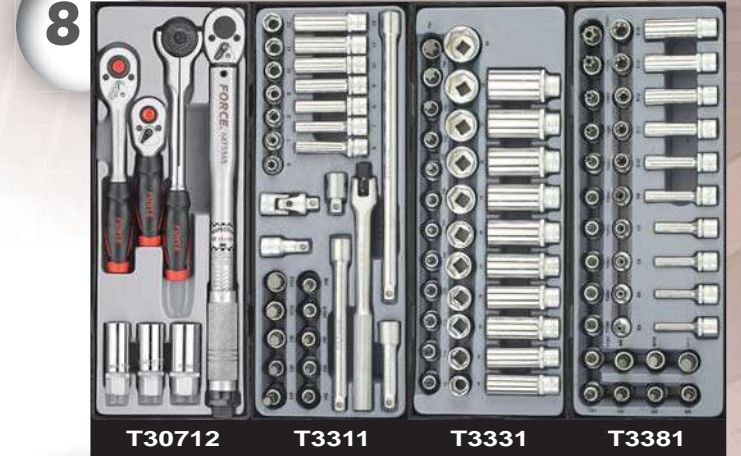

- 1013-562 ■ 1013R-562
- 1013B-562 ■ 1013A-562

1/181.68/190.43/23.7

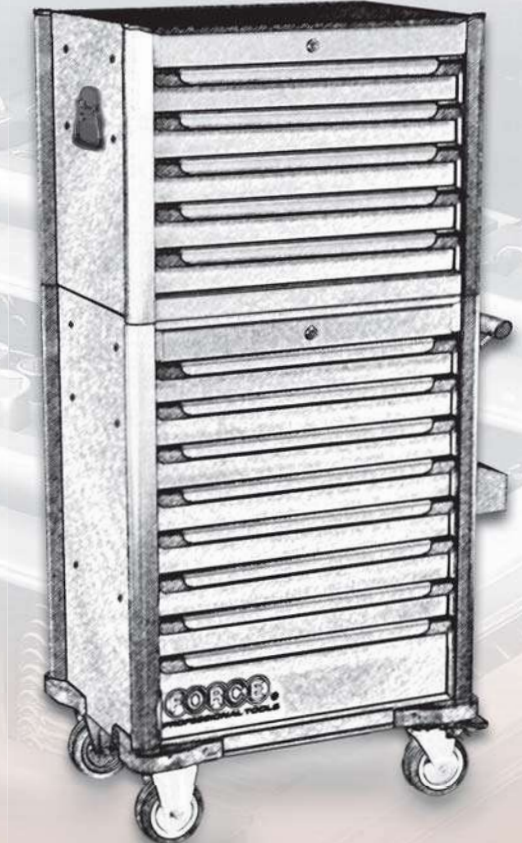

Jumbo Practical series

Packaged Accessories

Optional Accessories



■ 103180G ■ 103180RG
■ 103180BG
• Driving handle



■ 103180P
Top plate



■ 102170LK
• Foldable key to prevent from breaking due to casual bumping



• Full screw track allows height adjustable



■ 103106 ■ 103106R
■ 103106B
Can holder



• Strong caster with brake
• Plastic corner for protection



• Plastic-under provides coldness isolation for hand



■ 102104 ■ 102104R ■ 102104B
Side table



■ 102105 ■ 102105R
■ 102105B
Paper holder



■ 102102 ■ 102102R
■ 102102B
Side shelf



■ 103180BBS
• Ball bearing slides
• Only one drawer openable at a time



■ 102101 ■ 102101R
■ 102101B

Side lock cabinet
With 2pcs of 82022DW (2" double hooks)



Practical 8-drawer jumbo trolley



10318



10318R



10318B

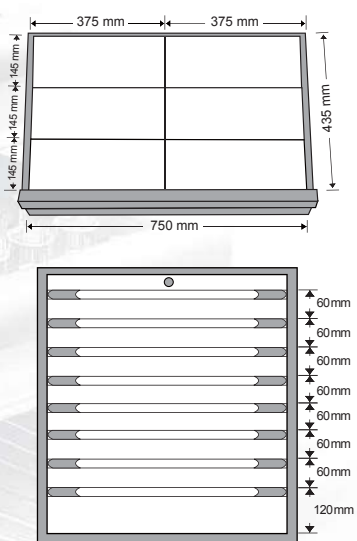

• L95 x W50 x H103 cm
1/97.7/103.2/20.2'

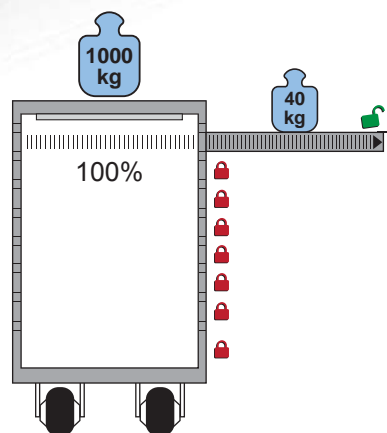

Practical 3-drawer jumbo tool box



10323



10323B

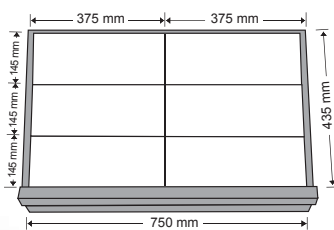

• L95 x W50 x H36 cm
1/37.4/40.6/10.2'

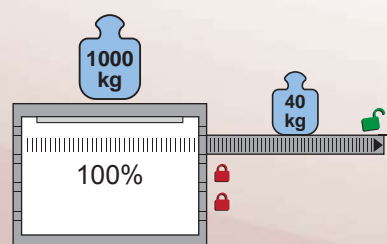

10323R

437pcs Tools

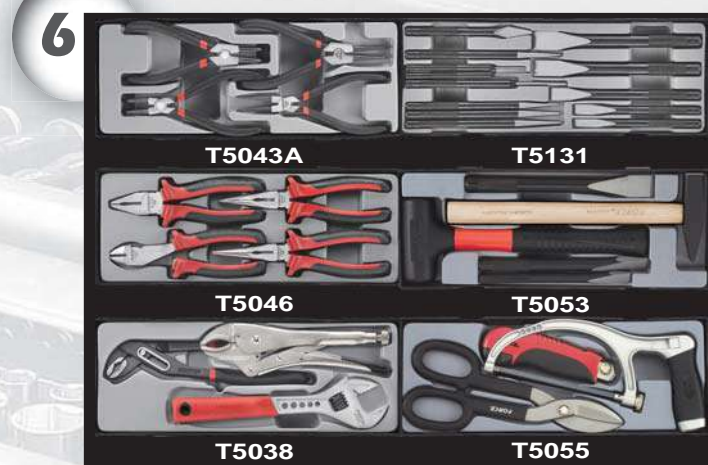
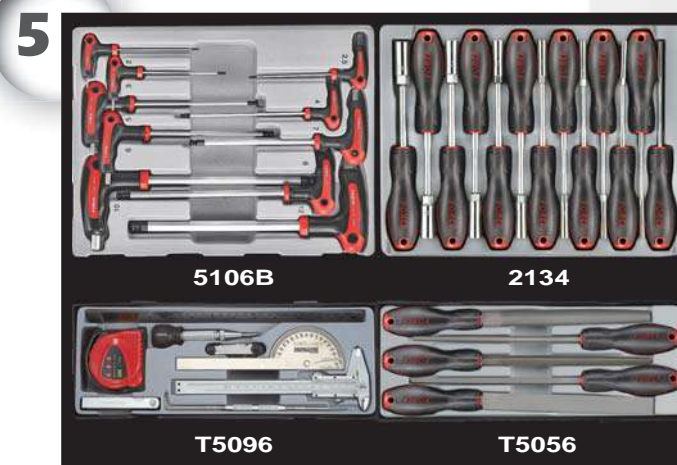

10318R-437



10318B-437



10318-437

552pcs Tools (S&M)



10318R-552
1/207.2/212.7/20.2'



10318B-552



10318-552

8pc Screwdriver set

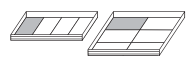

T2084 6/5.0/6.0/0.65' 833g

	2pc	PH.1 (80mmL); PH.2 (100mmL)
		3mm (75mmL); 3.5mm (100mmL);
	6pc	4mm (100mmL); 5.5mm (125mmL);
		6.5mm (150mmL); 8mm (175mmL)

8pc Screwdriver set

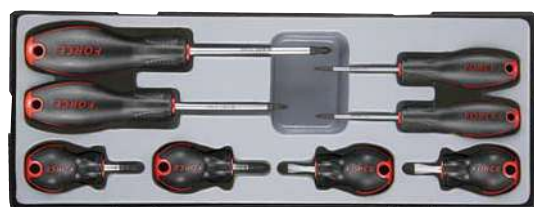

T2085 6/5.8/6.8/0.72' 966g

	1pc	PH.1 (25mmL)
	1pc	PH.0 (60mmL)
	1pc	PZ.1 (25mmL)
	3pc	PZ.0 (60mmL); PZ.1 (80mmL); PZ.2 (100mmL)
	2pc	5.5; 6.5 mm (25mmL)

14pc Screwdriver set

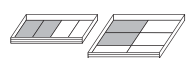

2142 6/8.0/9.0/1.3' 1333g

	2pc	PH.1; PH.2 (25mmL)
	4pc	PH.0 (60mmL); PH.1 (80mmL);
		PH.2 (100mmL); PH.3 (150mmL)
	2pc	5.5; 6.5 mm (25mmL)
		3mm (75mmL); 3.5mm (100mmL);
	6pc	4mm (100mmL); 5.5mm (125mmL);
		6.5mm (150mmL); 8mm (175mmL)

14pc Screwdriver set



2143 6/8.2/9.2/1.3' 1370g

	2pc	PZ.1; PZ.2 (25mmL)
	4pc	PZ.0 (60mmL); PZ.1 (80mmL);
		PZ.2 (100mmL); PZ.3 (150mmL)
	2pc	5.5; 6.5 mm (25mmL)
		3mm (75mmL); 3.5mm (100mmL);
	6pc	4mm (100mmL); 5.5mm (125mmL);
		6.5mm (150mmL); 8mm (175mmL)

6pc Hammer screwdriver set

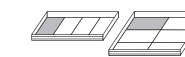

NEW



T20610A 6/8.4/9.4/0.65' 1400g

	1pc	PH.2 (100mmL)
		5.5mm (125mmL); 6.5mm (150mmL);
	5pc	8mm (150mmL); 10mm (200mmL);
		12mm (200mmL)

10pc Hammer screwdriver set

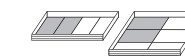

2108 6/15.2/16.2/1.3' 2530g

	4pc	PH.1 (80mmL); PH.2 (100mmL);
		PH.3 (150mmL); PH.4 (200mmL)
		5.5mm (125mmL); 6.5mm (150mmL);
	6pc	8mm (150mmL); 10mm (200mmL);
		12mm (200mmL); 14mm (250mmL)

10pc Hammer screwdriver set

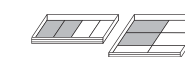

2109 6/15.2/16.2/1.3' 2530g

	4pc	PZ.1 (80mmL); PZ.2 (100mmL);
		PZ.3 (150mmL); PZ.4 (200mmL)
		5.5mm (125mmL); 6.5mm (150mmL);
	6pc	8mm (150mmL); 10mm (200mmL);
		12mm (200mmL); 14mm (250mmL)

8pc Hex screwdriver set

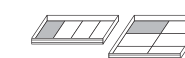



T20810 6/6.0/7.0/0.72' 1000g

	8pc	2; 2.5; 3; 4; 5 mm (100mmL)
		6mm (125mmL); 8mm (150mmL);
		10mm (150mmL)

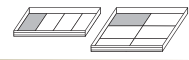
8pc Hex ball screwdriver set





T20810B  6/5.9/6.9/0.72'  980g

	8pc	2; 2.5; 3; 4; 5 mm (100mmL)
		6mm (125mmL); 8mm (150mmL);
		10mm (150mmL)

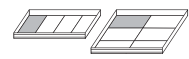
8pc Star screwdriver set





T2086  6/5.5/6.5/0.65'  917g

	8pc	T8 (60mmL); T10 (80mmL); T15 (80mmL);
		T20 (100mmL); T25 (100mmL);
		T27 (115mmL); T30 (115mmL); T40 (130mmL)

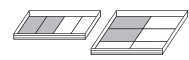
13pc Star screwdriver set





2137  6/7.7/8.7/1.3'  1283g

	13pc	T5; T6; T7; T8; T9 (60mmL)
		T10; T15 (80mmL)
		T20; T25 (100mmL)
		T27; T30 (115mmL)
		T40; T45 (130mmL)

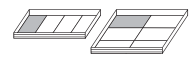
8pc Star tamperproof screwdriver set





T2086T  6/5.5/6.5/0.65'  917g

	8pc	T-8H (60mmL); T-10H (80mmL);
		T-15H (80mmL); T-20H (100mmL);
		T-25H (100mmL); T-27H (115mmL);
		T-30H (115mmL); T-40H (130mmL)

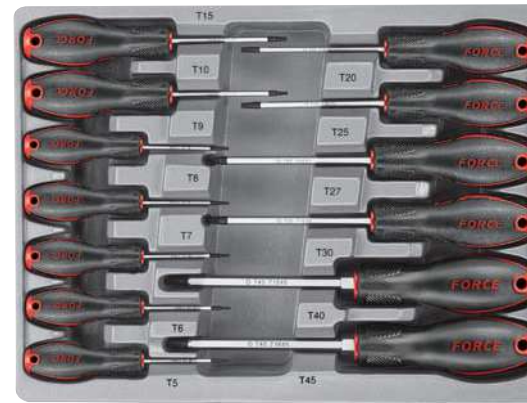
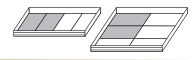
13pc Star tamperproof screwdriver set



2137T  6/7.3/8.3/1.3'  1217g

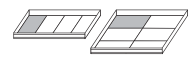

	13pc	T-5H; T-6H; T-7H; T-8H; T-9H (60mmL)
		T-10H; T-15H (80mmL)
		T-20H; T-25H (100mmL)
		T-27H; T-30H (115mmL)
		T-40H; T-45H (130mmL)

6pc Hex socket driver set



NEW





T20612  6/6.5/7.5/0.65'  1080g

	6pc	6; 7; 8; 10; 12; 13 mm (135mmL)

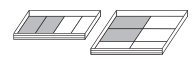
13pc Hex socket driver set



2134  6/12.6/13.6/1.3'  2100g

	13pc	4; 4.5; 5; 5.5; 6; 7; 8; 9; 10 mm (135mmL)
		11; 12; 13; 14 mm (135mmL)

7pc Insulated screwdriver set



T20712N 6/4.1/5.1/0.65' 683g

	2pc	PH.1 (80mmL); PH.2 (100mmL)
	4pc	3mm (100mmL); 4mm (100mmL); 5.5mm (125mmL); 6.5mm (150mmL)
	1pc	Adjustable non-contact wire tracer (88407)

7pc Insulated screwdriver set

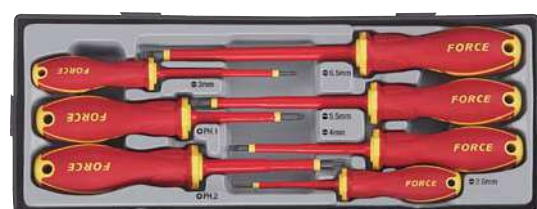

T20715N 6/4.1/5.1/0.65' 683g

	2pc	PH.1 (80mmL); PH.2 (100mmL)
	5pc	2.5mm (75mmL); 3mm (100mmL); 4mm (100mmL); 5.5mm (125mmL); 6.5mm (150mmL)

7pc Insulated screwdriver set



T20718N 6/3.8/4.8/0.65' 633g

	2pc	PH.1 (80mmL); PH.2 (100mmL)
	4pc	2.5mm (75mmL); 3.5mm (100mmL); 5.5mm (125mmL); 6.5mm (150mmL)
	1pc	Multi-function screwdriver voltage tester (88411)

9pc Insulated screwdriver set



T20916N 6/9.0/10.0/0.65' 1500g

	2pc	PH.1 (80mmL); PH.2 (100mmL)
	6pc	2.5mm (75mmL); 3mm (100mmL); 3.5mm (100mmL); 4mm (100mmL); 5.5mm (125mmL); 6.5mm (150mmL)
	1pc	Multi-function screwdriver voltage tester (88411)

12pc Insulated screwdriver set

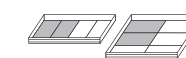

2125N 6/7.5/8.5/1.3' 1250g

	4pc	PH.0 (60mmL); PH.1 (80mmL); PH.2 (100mmL); PH.3 (150mmL)
	7pc	2.5mm (75mmL); 3mm (100mmL); 3.5mm (100mmL); 4mm (100mmL); 5.5mm (125mmL); 6.5mm (150mmL); 8mm (175mmL)
	1pc	Adjustable non-contact wire tracer (88407)

12pc Insulated screwdriver set



2126N 6/7.6/8.6/1.3' 1260g

	4pc	PZ.0 (60mmL); PZ.1 (80mmL); PZ.2 (100mmL); PZ.3 (150mmL)
	7pc	2.5mm (75mmL); 3mm (100mmL); 3.5mm (100mmL); 4mm (100mmL); 5.5mm (125mmL); 6.5mm (150mmL); 8mm (175mmL)
	1pc	Adjustable non-contact wire tracer (88407)

6pc Insulated hex socket driver set

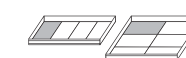

NEW



T20612N 6/6.1/7.1/0.65' 1016g

	6pc	6; 7; 8; 10; 12; 13 mm (125mmL)
--	-----	---------------------------------

9pc Insulated hex socket driver set



NEW



20917 6/9.7/10.7/1.3' 1617g

	9pc	5; 6; 7; 8; 9; 10; 11; 12; 13 mm (125mmL)
--	-----	---

17pc Jeweler screwdriver & (de-)magnetizer set

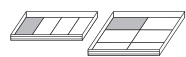

NEW

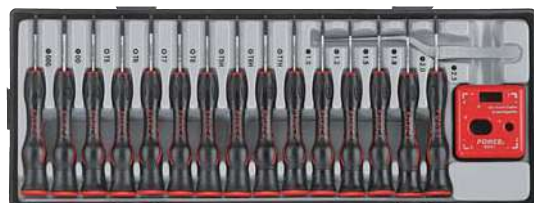

T2173A

6/3.5/4.5/0.65' 583g

	2pc	PH.000; PH.00 (40mmL)
	6pc	1.0; 1.2; 1.5; 1.8; 2.0; 2.5 mm (40mmL)
	4pc	T5; T6; T7; T8 (40mmL)
	3pc	T-5H; T-6H; T-7H (40mmL)
	1pc	Tweezers 5.5"(140mm) (6945140)
	1pc	Demagnetizer / Magnetizer (88601)

30pc L key and five-sided star tamperproof bit set



NEW



T5303

6/6.7/7.7/0.65' 1116g

	10pc	1/4" TS8; TS10; TS15; TS20; TS25; TS27; TS30; TS40; TS45; TS50 (25mmL) (21013)
	1pc	1/4"DR.x1/4"(F)
	10pc	1.27; 1.5; 2; 2.5; 3; 4; 5; 6; 8; 10 mm (5102XLB)
	9pc	T10; T15; T20; T25; T27; T30; T40; T45; T50 (5098XL)

29pc L key and five-sided star tamperproof bit set (SAE)



NEW



T5303S

6/7.0/8.0/0.65' 1162g

	10pc	1/4" TS8; TS10; TS15; TS20; TS25; TS27; TS30; TS40; TS45; TS50 (25mmL) (21013)
	1pc	1/4"DR.x1/4"(F)
	9pc	1/16"; 5/64"; 3/32"; 1/8"; 5/32"; 3/16"; 1/4"; 5/16"; 3/8" (5093XLBS)
	9pc	T10; T15; T20; T25; T27; T30; T40; T45; T50 (5098XL)

4pc 1/4"DR. Ratchet handle set

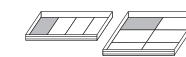

T2045

6/7.1/8.1/0.65' 1183g

	1pc	5-25 Nm, 270mmL (6472270)
	1pc	QR pear ratchet handle 20teeth (802215)
	1pc	QR flexible pear ratchet handle 20teeth (802218)
	1pc	QR stubby pear ratchet handle 20teeth (802219)

65pc 1/4"DR. 6pt. Flank socket combination set



T2641

6/10.7/11.7/0.65' 1783g

	14pc	3.2; 4; 4.5; 5; 5.5; 6; 7; 8; 9; 10; 11; 12; 13; 14 mm
	9pc	5; 6; 7; 8; 9; 10; 11; 12; 13 mm (50mmL)
	3pc	PH.1; PH.2; PH.3 (32mmL)
	3pc	PZ.1; PZ.2; PZ.3 (32mmL)
	3pc	4; 5.5; 6.5 mm (32mmL)
	7pc	3; 4; 5; 6; 7; 8; 10 mm (32mmL)
	8pc	T8; T10; T15; T20; T25; T27; T30; T40 (32mmL)
	1pc	Round ratchet handle 72teeth (802222)
	3pc	2"(50mm); 4"(100mm); 6"(150mm)
	1pc	4.5"(115mm)
	1pc	1/4"
	1pc	Magnetic socket pick-up (25mmL)
	1pc	6"(150mm) with 1/4"DR.(F)
	10pc	1.27; 1.5; 2; 2.5; 3; 4; 5; 6; 8; 10 mm (5102XLB)

T2641-8

6/11.2/12.2/0.65' 1871g

Changed items		
	1pc	QR pear ratchet handle 72teeth (80228)

T2641-15

6/11.0/12.0/0.65' 1833g

Changed items		
	1pc	QR pear ratchet handle 20teeth (802215)

74pc 1/4"DR. 6pt. Flank & star socket combination set

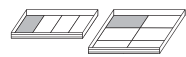

T2742 6/9.4/10.4/0.65' 1566g

	12pc	4; 4.5; 5; 5.5; 6; 7; 8; 9; 10; 11; 12; 13 mm
	12pc	4; 4.5; 5; 5.5; 6; 7; 8; 9; 10; 11; 12; 13 mm (50mmL)
	6pc	E4; E5; E6; E7; E8; E10
	6pc	E4; E5; E6; E7; E8; E10 (50mmL)
	3pc	PH.0; PH.1; PH.2 (32mmL)
	3pc	PZ.0; PZ.1; PZ.2 (32mmL)
	3pc	4; 5.5; 6.5 mm (32mmL)
	7pc	3; 4; 5; 6; 7; 8; 10 mm (32mmL)
	8pc	T8; T10; T15; T20; T25; T27; T30; T40 (32mmL)
	8pc	T-8H; T-10H; T-15H; T-20H; T-25H; T-27H; T-30H; T-40H (32mmL)
	1pc	T mini ratchet handle 48teeth (802220)
	3pc	2"(50mm); 4"(100mm); 6"(150mm)
	1pc	1/4"
	1pc	Magnetic socket pick-up (25mmL)

T2742-15 6/9.1/10.1/0.65' 1517g

Changed items

	1pc	QR pear ratchet handle 20teeth (802215)
--	-----	---

T2742-18 6/9.6/10.6/0.65' 1600g

Changed items

	1pc	QR flexible pear ratchet handle 20teeth (802218)
--	-----	--

T2742-8 6/9.6/10.6/0.65' 1600g

Changed items

	1pc	QR pear ratchet handle 72teeth (80228)
--	-----	--

74pc 1/4"DR. 6pt. Flank socket combination set (S&M)



T2741 6/10.3/11.3/0.65' 1716g

	12pc	4; 4.5; 5; 5.5; 6; 7; 8; 9; 10; 11; 12; 13 mm
	6pc	3/16"; 1/4"; 9/32"; 11/32"; 3/8"; 1/2"
	12pc	4; 4.5; 5; 5.5; 6; 7; 8; 9; 10; 11; 12; 13 mm (50mmL)
	6pc	3/16"; 1/4"; 9/32"; 11/32"; 3/8"; 1/2" (50mmL)
	3pc	PH.1; PH.2; PH.3 (32mmL)
	3pc	PZ.1; PZ.2; PZ.3 (32mmL)
	4pc	3; 4; 5.5; 6.5 mm (32mmL)
	7pc	3; 4; 5; 6; 7; 8; 10 mm (32mmL)
	5pc	1/8"; 3/16"; 7/32"; 1/4"; 3/8" (32mmL)
	8pc	T8; T10; T15; T20; T25; T27; T30; T40 (32mmL)
	1pc	QR pear ratchet handle 20teeth (802215)
	3pc	2"(50mm); 4"(100mm); 6"(150mm)
	1pc	4.5"(115mm)
	1pc	1/4"
	1pc	Magnetic socket pick-up (25mmL)
	1pc	6"(150mm) with 1/4"DR.(F)

7pc 3/8"DR. Ratchet handle set

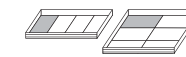

T30712 6/14.1/15.1/0.65' 2283g

	3pc	Spark plug 16; 18; 20.6 mm
	1pc	20-110 Nm, 365mmL (6473365)
	1pc	QR pear ratchet handle 24teeth (80232)
	1pc	QR stubby pear ratchet handle 30teeth (802319)
	1pc	Flexible round ratchet handle 72teeth (802323)

24pc 3/8"DR. Socket combination set

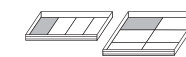

T3251 6/10.8/11.8/0.65' 1800g

	17pc	6; 7; 8; 9; 10; 11; 12; 13; 14; 15; 16; 17; 18; 19; 20; 21; 22 mm
	2pc	Spark plug 16; 20.6 mm
	1pc	QR pear ratchet handle 24teeth (80232)
	2pc	3"(75mm); 6"(150mm)
	1pc	6.5"(165mm)
	1pc	3/8"

T3251-72 6/11.0/12.0/0.65' 1833g

Changed items

	1pc	Round ratchet handle 72teeth (802322)
--	-----	---------------------------------------

T3251-72-5 6/11.3/12.3/0.65' 1883g

Changed items

	17pc	6; 7; 8; 9; 10; 11; 12; 13; 14; 15; 16; 17; 18; 19; 20; 21; 22 mm
	1pc	Round ratchet handle 72teeth (802322)

T3251-5 6/11.3/12.3/0.65' 1883g

Changed items

	17pc	6; 7; 8; 9; 10; 11; 12; 13; 14; 15; 16; 17; 18; 19; 20; 21; 22 mm
--	------	---

T3251-5-8 6/11.9/12.9/0.65' 1980g

Changed items

	17pc	6; 7; 8; 9; 10; 11; 12; 13; 14; 15; 16; 17; 18; 19; 20; 21; 22 mm
	1pc	QR pear ratchet handle 72teeth (80238)

T3251-5-15 6/11.3/12.3/0.65' 1883g

Changed items

	17pc	6; 7; 8; 9; 10; 11; 12; 13; 14; 15; 16; 17; 18; 19; 20; 21; 22 mm
	1pc	QR pear ratchet handle 30teeth (802315)

T3251-5-18 6/11.9/12.9/0.65' 1980g

Changed items

	17pc	6; 7; 8; 9; 10; 11; 12; 13; 14; 15; 16; 17; 18; 19; 20; 21; 22 mm
	1pc	QR flexible pear ratchet handle 30teeth (802318)

36pc 3/8"DR. 6pt. Flank socket & combination wrench set

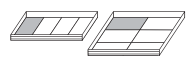

T3361

6/16.4/17.4/0.72' Δ 2733g

	17pc	6; 7; 8; 9; 10; 11; 12; 13; 14; 15; 16; 17; 18; 19; 20; 21; 22 mm
	2pc	Spark plug 16; 20.6 mm
	1pc	Round ratchet handle 72teeth (802322)
	3pc	3"(75mm); 6"(150mm); 9"(225mm)
	1pc	3/8"
	1pc	1/2"(F)x3/8"(M) for extension
	11pc	7; 8; 9; 10; 11; 12; 13; 14; 15; 16; 17 mm

12pc 3/8"DR. 6pt. Flank deep socket set



T3121

6/7.2/8.2/0.65' Δ 1200g

	12pc	8; 10; 11; 12; 13; 14; 15; 16; 17; 18; 19; 22 mm (63mmL)
--	------	--

31pc 3/8"DR. 6pt. Flank socket combination set

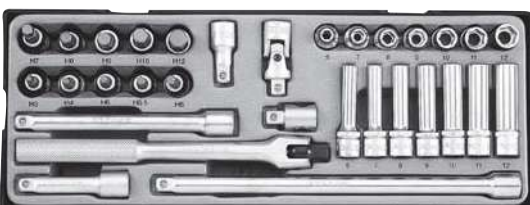

T3311

6/12.0/13.0/0.78' Δ 2000g

	7pc	6; 7; 8; 9; 10; 11; 12 mm
	7pc	6; 7; 8; 9; 10; 11; 12 mm (63mmL)
	10pc	3; 4; 5; 5.5; 6; 7; 8; 9; 10; 12 mm (50mmL)
	1pc	8.5"(215mm)
	4pc	1.75"(44mm); 3"(75mm); 6"(150mm); 10"(250mm)
	1pc	3/8"
	1pc	3/8"(F)x3/8"(M) for extension

33pc 3/8"DR. 6pt. Flank & star socket bit set



T3331

6/14.4/15.4/0.78' Δ 2400g

	11pc	13; 14; 15; 16; 17; 18; 19; 20; 21; 22; 24 mm
	10pc	13; 14; 15; 16; 17; 18; 19; 20; 21; 22 mm (63mmL)
	12pc	T8; T10; T15; T20; T25; T27; T30; T40; T45; T50; T55; T60 (50mmL)

38pc 3/8"DR. Star & spline set

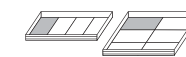

T3381

6/10.4/11.4/0.78' Δ 1730g

	10pc	E4; E5; E6; E7; E8; E10; E11; E12; E14; E16
	10pc	E4; E5; E6; E7 (55mmL) E8; E10; E11; E12; E14; E16 (63mmL)
	12pc	T-8H; T-10H; T-15H; T-20H; T-25H; T-27H; T-30H; T-40H; T-45H; T-50H; T-55H; T-60H (50mmL)
	6pc	M5; M6; M8; M9; M10; M12 (50mmL)

38pc 3/8"DR. Star set



NEW



T3382

6/11.5/12.5/0.65' Δ 1916g

	12pc	E4; E5; E6; E7; E8; E10; E11; E12; E14; E16; E18; E20
	11pc	E4; E5; E6; E7 (55mmL) E8; E10; E11; E12; E14; E16; E18 (63mmL)
	6pc	T30; T40; T45; T50; T55; T60 (50mmL)
	9pc	T10; T15; T20; T25; T27; T30; T40; T45; T50 (5098XL)

T3382T

6/11.5/12.5/0.65' Δ 1916g

Changed items		
	9pc	T-10H; T-15H; T-20H; T-25H; T-27H; T-30H; T-40H; T-45H; T-50H (5098XLT)

T3382TT

6/11.5/12.5/0.65' Δ 1916g

Changed items		
	6pc	T-30H; T-40H; T-45H; T-50H; T-55H; T-60H (50mmL)
	9pc	T-10H; T-15H; T-20H; T-25H; T-27H; T-30H; T-40H; T-45H; T-50H (5098XLT)

22pc 3/8"DR. Universal socket set



T3224

6/13.6/14.6/0.65' Δ 2266g

	10pc	10; 11; 12; 13; 14; 15; 16; 17; 18; 19 mm (42mmL)
	10pc	10; 11; 12; 13; 14; 15; 16; 17; 18; 19 mm (85mmL)
	2pc	Magnetic spark plug 16; 20.6 mm

52pc 1/4" & 3/8" & 1/2" Star set

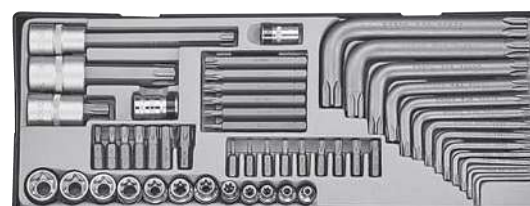
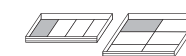

T3521

6/11.4/12.4/0.65' Δ 1900g

	5pc	1/4"DR. E4; E5; E6; E7; E8
	7pc	3/8"DR. E10; E11; E12; E14; E16; E18; E20
	7pc	5/16" T20; T25; T30; T40; T45; T50; T55 (30mmL)
	1pc	1/2"DR. T60 (55mmL)
	6pc	5/16" T20; T25; T30; T40; T45; T50 (70mmL)
	2pc	1/2"DR. T70 (100mmL); T55 (140mmL)
	9pc	1/4" T-8H; T-10H; T-15H; T-20H; T-25H; T-27H; T-30H; T-35H; T-40H (25mmL)
	2pc	1/4"DR.x1/4"(F); 3/8"DR.x5/16"(F)
	13pc	T9; T10; T15; T20; T25; T27; T30; T40; T45; T50; T55; T60; T70

21pc 3/8"DR. 6pt. Flank socket combination set (SAE)

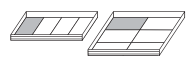

T3212

6/12.2/13.2/0.65' Δ 2040g

	13pc	1/4"; 5/16"; 3/8"; 7/16"; 1/2"; 9/16"; 19/32"; 5/8"; 11/16"; 3/4"; 25/32"; 13/16"; 7/8"
	2pc	Spark plug 16mm (5/8"); 20.6mm (13/16")
	1pc	QR pear ratchet handle 24teeth (80232)
	3pc	3"(75mm); 6"(150mm); 10"(250mm)
	1pc	6.5"(165mm)
	1pc	3/8"

19pc 3/8"DR. 6pt. Flank socket set (SAE)



T3193

6/7.3/8.3/0.65' Δ 1210g

	11pc	1/4"; 5/16"; 3/8"; 7/16"; 1/2"; 9/16"; 5/8"; 11/16"; 3/4"; 13/16"; 7/8"
	8pc	5/16"; 3/8"; 7/16"; 1/2"; 9/16"; 5/8"; 11/16"; 3/4" (63mmL)

32pc 3/8"DR. 6pt. Flank socket combination set (S&M)



T3322

6/13.2/14.2/0.65' Δ 2200g

	17pc	6; 7; 8; 9; 10; 11; 12; 13; 14; 15; 16; 17; 18; 19; 20; 21; 22 mm
	7pc	1/4"; 3/8"; 1/2"; 9/16"; 5/8"; 11/16"; 13/16"
	2pc	Spark plug 16mm (5/8"); 20.6mm (13/16")
	1pc	Round ratchet handle 72teeth (802322)
	3pc	3"(75mm); 6"(150mm); 9"(225mm)
	1pc	3/8"
	1pc	1/2"(F)x3/8"(M) for extension

T3322-15

6/13.3/14.3/0.72' Δ 2216g

Changed items	1pc	QR pear ratchet handle 30teeth (802315)
---------------	-----	---

T3322-23

6/15.0/16.0/0.72' Δ 2500g

Changed items	1pc	Flexible round ratchet handle 72teeth (802323)
---------------	-----	--

T3322-24

6/15.0/16.0/0.72' Δ 2500g

Changed items	1pc	QR pear ratchet handle 24teeth (80232)
---------------	-----	--

5pc 1/2"DR. Accessory set

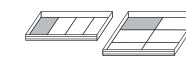

T4057

6/11.1/12.1/0.65' Δ 1850g

	1pc	Round ratchet handle 72teeth (802422)
	2pc	5"(125mm); 10"(250mm)
	1pc	10"(250mm)
	1pc	1/2"

T4057-15

6/12.0/13.0/0.65' Δ 2000g

Changed items	1pc	QR pear ratchet handle 36teeth (802415)
---------------	-----	---

6pc 1/2"DR. Accessory set



T40612

6/16.6/17.6/0.65' Δ 2767g

	1pc	QR pear ratchet handle 36teeth (802415)
	1pc	15"(380mm)
	2pc	5"(125mm); 10"(250mm)
	1pc	10"(250mm)
	1pc	1/2"

6pc 1/2"DR. Accessory set



T40613-23

6/17.1/18.1/0.65' Δ 2850g

	1pc	Flexible round ratchet handle 72teeth (802423)
	1pc	15"(380mm)
	2pc	5"(125mm); 10"(250mm)
	1pc	10"(250mm)
	1pc	1/2"

22pc 1/2"DR. Socket combination set



NEW



T4226

6/17.0/18.0/0.65' Δ 2840g

	17pc	8; 9; 10; 11; 12; 13; 14; 15; 16; 17; 18; 19; 20; 21; 22; 23; 24 mm
	1pc	QR pear ratchet handle 72teeth (80248)
	2pc	5"(125mm); 10"(250mm)
	1pc	1/2"
	1pc	3/8"(F)x1/2"(M) for extension

T4226Q

6/16.5/17.5/0.65' Δ 2750g

Changed items	17pc	Spline socket 8; 9; 10; 11; 12; 13; 14; 15; 16; 17; 18; 19; 20; 21; 22; 23; 24 mm
---------------	------	---

21pc 1/2"DR. 6pt. Flank socket set

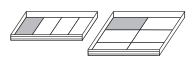

NEW



T4217

6/19.2/20.2/0.65' Δ 3195g

	6pc	25; 26; 27; 28; 30; 32 mm
	15pc	10; 11; 12; 13; 14; 15; 16; 17; 18; 19; 20; 21; 22; 23; 24 mm (77mmL)

21pc 1/2"DR. Socket set



T4212

6/12.5/13.5/0.72' Δ 2080g

	21pc	8; 10; 11; 12; 13; 14; 15; 16; 17; 18; 19; 20; 21; 22; 23; 24; 26; 27; 28; 30; 32 mm
--	------	--

T4212-7

6/12.5/13.5/0.72' Δ 2080g

	21pc	8; 10; 11; 12; 13; 14; 15; 16; 17; 18; 19; 20; 21; 22; 23; 24; 26; 27; 28; 30; 32 mm
--	------	--

T4212-9

6/12.0/13.0/0.72' Δ 2000g

	21pc	8; 10; 11; 12; 13; 14; 15; 16; 17; 18; 19; 20; 21; 22; 23; 24; 26; 27; 28; 30; 32 mm
--	------	--

14pc 1/2"DR. Deep socket set

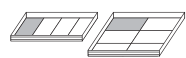

T4143

6/16.1/17.1/0.65' Δ 2680g

	14pc	10; 12; 13; 14; 15; 17; 19; 21; 22; 23; 24; 27; 30; 32 mm (77mmL)
--	------	---

T4143-9

6/15.8/16.8/0.65' Δ 2633g

	14pc	10; 12; 13; 14; 15; 17; 19; 21; 22; 23; 24; 27; 30; 32 mm (77mmL)
--	------	---

24pc 1/2"DR. 6pt. Flank socket set



T4248

6/12.6/13.6/0.72' Δ 2100g

	12pc	8; 9; 10; 11; 12; 13; 14; 15; 16; 17; 18; 19 mm
	12pc	8; 9; 10; 11; 12; 13; 14; 15; 16; 17; 18; 19 mm (77mmL)

20pc 1/2"DR. 6pt. Flank socket set

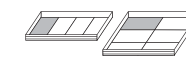

T4203

6/24.4/25.4/0.78' Δ 4067g

	10pc	20; 21; 22; 23; 24; 26; 27; 28; 30; 32 mm
	10pc	20; 21; 22; 23; 24; 26; 27; 28; 30; 32 mm (77mmL)

17pc 1/2"DR. Hex socket bit set

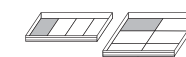

NEW



T41710

6/13.7/14.7/0.65' Δ 2283g

	9pc	5; 6; 7; 8; 10; 12 mm (55mmL) 14mm (65mmL) 17; 19 mm (70mmL)
	8pc	5; 6; 7; 8; 10; 12; 14 mm (100mmL) 17mm (110mmL)

16pc 1/2"DR. Star socket bit set



NEW



T4165

6/10.1/11.1/0.65' Δ 1683g

	8pc	T27; T30; T40; T45; T50; T55; T60; T70 (55mmL)
	8pc	T27; T30; T40; T45; T50; T55; T60; T70 (100mmL)

17pc 1/2"DR. Spline socket bit set



NEW



T4179

6/12.8/13.8/0.65' Δ 2133g

	8pc	M5; M6; M8; M9; M10; M12; M14; M16 (55mmL)
	8pc	M5; M6; M8; M9; M10; M12; M14; M16 (100mmL)
	1pc	M16 (55mmL)

11pc 1/2"DR. Socket bit set

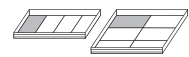

T4116

6/9.5/10.5/0.65' 1580g

	5pc	7mm (100mmL); 8mm (120mmL); 10mm (140mmL); 6mm (160mmL); 5mm (180mmL)
	3pc	T70 (100mmL) T45; T55 (140mmL)
	3pc	M8 (100mmL); M10 (120mmL); M12 (140mmL)

12pc 1/2"DR. Socket bit set



T4122

6/9.3/10.3/0.65' 1550g

	4pc	6; 7; 8 mm (100mmL) 5mm (180mmL)
	4pc	T40; T45 (120mmL) T55; T70 (140mmL)
	4pc	M6; M8; M10; M12 (100mmL)

27pc 3/8" & 1/2" Socket bit set



T4281

6/15.5/16.5/0.65' 2580g

	6pc	3/8"DR. 4; 5; 6; 7; 8; 10 mm (50mmL)
	9pc	1/2"DR. 4; 5; 6; 7; 8; 10; 12 mm (55mmL) 14mm (65mmL); 17mm (70mmL)
	2pc	1/2"DR. 8mm (80mmL); 10mm (140mmL)
	7pc	1/2"DR. M5; M6; M8; M10; M12; M14; M16 (55mmL)
	3pc	1/2"DR. M10; M12 (110mmL); M8 (120mmL)

35pc 1/2"DR. Socket bit & star socket set



NEW



T4355

6/19.8/20.8/0.78' 3300g

	9pc	E10; E11; E12; E14; E16; E18; E20; E22; E24 5; 6; 7; 8; 10; 12 mm (55mmL)
	9pc	14mm (65mmL) 17; 19 mm (70mmL)
	8pc	T27; T30; T40; T45; T50; T55; T60; T70 (55mmL)
	8pc	M5; M6; M8; M9; M10; M12; M14; M16 (55mmL)
	1pc	M16 (55mmL)

32pc 1/2"DR. Socket bit & star socket set

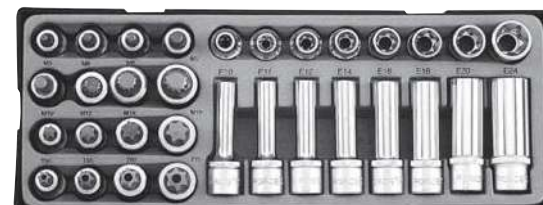
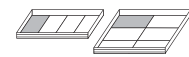

T4322

6/18.7/19.7/0.78' 3120g

	8pc	E10; E11; E12; E14; E16; E18; E20; E24
	8pc	E10; E11; E12; E14; E16; E18; E20; E24 (77mmL)
	4pc	T50; T55; T60; T70 (55mmL)
	4pc	T-50H; T-55H; T-60H; T-70H (55mmL)
	8pc	M5; M6; M8; M9; M10; M12; M14; M16 (55mmL)

41pc 1/4" & 3/8" & 1/2" Star set

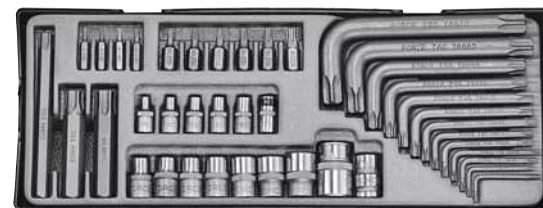
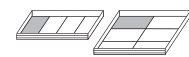

T4411

6/10.4/11.4/0.66' 1730g

	5pc	1/4"DR. E4; E5; E6; E7; E8
	7pc	3/8"DR. E10; E11; E12; E14; E16; E18; E20
	4pc	1/4" T9; T10; T15; T20 (30mmL)
	6pc	10mm T25; T27; T30; T40; T45; T50 (30mmL)
	1pc	10mm T55 (115mmL)
	2pc	14mm T60; T70 (75mmL)
	1pc	1/4"DR.x1/4"(F)
	1pc	3/8"DR.x10mm(F)
	1pc	1/2"DR.x14mm(F)
	13pc	T9; T10; T15; T20; T25; T27; T30; T40; T45; T50; T55; T60; T70

41pc 1/4" & 3/8" & 1/2" Star set

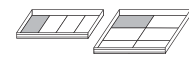

T4413

6/12.7/13.7/0.78' 2117g

	6pc	1/4"DR. E4; E5; E6; E7; E8; E10
	7pc	3/8"DR. E10; E11; E12; E14; E16; E18; E20
	2pc	1/2"DR. E22; E24
	9pc	1/4"DR. T8; T9; T10; T15; T20; T25; T27; T30; T40 (32mmL)
	2pc	3/8"DR. T45; T50 (50mmL)
	3pc	1/2"DR. T55 (140mmL) T60; T70 (100mmL)
	7pc	T10; T15; T20; T25; T27; T30; T40 (5071)
	5pc	T45; T50; T55; T60; T70

58pc 10mm Bit & 1/2"DR. Star socket set

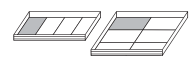

NEW



T4583

6/14.1/15.1/0.65' 2358g

	10pc	1/2"DR. E8; E10; E11; E12; E14; E16; E18; E20; E22; E24
	7pc	10mm 4; 5; 6; 7; 8; 10; 12 mm (30mmL)
	7pc	10mm 4; 5; 6; 7; 8; 10; 12 mm (75mmL)
	9pc	10mm T20; T25; T27; T30; T40; T45; T50; T55; T60 (30mmL)
	9pc	10mm T20; T25; T27; T30; T40; T45; T50; T55; T60 (75mmL)
	7pc	10mm M5; M6; M7; M8; M9; M10; M12 (30mmL)
	7pc	10mm M5; M6; M7; M8; M9; M10; M12 (75mmL)
	2pc	3/8"DR.x10mm(F); 1/2"DR.x10mm(F)

19pc 1/2"DR. 6pt. Flank impact socket set

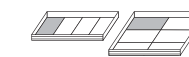

T4193

6/15.8/16.8/0.72' 2633g



	18pc	10; 11; 12; 13; 14; 15; 16; 17; 18; 19; 21; 22; 23; 24; 26; 27; 30; 32 mm
	1pc	Ball type 5" (125mm)

19pc 1/2"DR. 6pt. Flank socket set (SAE)



T4194

6/11.3/12.3/0.72' 1883g

	19pc	5/16"; 3/8"; 7/16"; 15/32"; 1/2"; 9/16"; 19/32"; 5/8"; 11/16"; 3/4"; 25/32"; 13/16"; 7/8"; 15/16"; 1"; 1-1/16"; 1-1/8"; 1-3/16"; 1-1/4"
--	------	---

11pc 1/2"DR. 6pt. Flank deep impact socket set

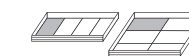

T4119

6/20.4/21.4/0.72' 3400g

	11pc	12; 14; 17; 19; 21; 22; 23; 24; 27; 30; 32 mm (85mmL)
--	------	---

24pc 1/2"DR. 6pt. Flank socket set (SAE)



T4248S

6/17.7/18.7/0.72' 2950g

	12pc	3/8"; 7/16"; 1/2"; 9/16"; 5/8"; 11/16"; 3/4"; 13/16"; 7/8"; 15/16"; 1"; 1-1/16"
	12pc	3/8"; 7/16"; 1/2"; 9/16"; 5/8"; 11/16"; 3/4"; 13/16"; 7/8"; 15/16"; 1"; 1-1/16" (77mmL)

8pc 1/2"DR. Deep impact socket set

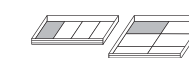

T40813

6/20.5/21.5/0.86' 3416g

	8pc	19; 22; 24; 27; 30; 32; 36; 41 mm (85mmL)
--	-----	---

T40813-5

6/20.5/21.5/0.86' 3416g

	8pc	19; 22; 24; 27; 30; 32; 36; 41 mm (85mmL)
--	-----	---

20pc 1/2"DR. Impact socket bit set (one-piece)

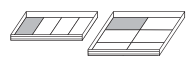

T4205

6/11.7/12.7/0.65' 1950g

	10pc	4; 5; 6; 7; 8; 10; 12; 14; 17; 19 mm (60mmL)
	10pc	T20; T25; T27; T30; T40; T45; T50; T55; T60; T70 (60mmL)

12pc 3/4"DR. 6pt. Flank impact socket set

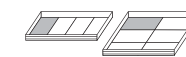

T6121

6/25.9/26.9/0.86' 4316g

	12pc	17; 19; 21; 22; 24; 27; 30; 32; 34; 36; 38; 41 mm
--	------	---

25pc 1/2"DR. Impact socket bit & star socket set



NEW



T4256

6/15.4/16.4/0.65' 2567g

	12pc	E6; E7; E8; E10; E11; E12; E14; E16; E18; E20; E22; E24
	7pc	T30; T40; T45; T50; T55; T60; T70 (60mmL)
	3pc	M8; M10; M12 (60mmL)
	3pc	M14; M16; M18 (78mmL)

8pc 3/4"DR. 6pt. Flank deep impact socket set



T6085

6/29.2/30.2/0.86' 4866g

	8pc	19; 22; 24; 27; 30; 32; 36; 41 mm (100mmL)
--	-----	--

21pc 1/2"DR. Impact wrench & socket set



4215

3/20.4/21.4/1.3' 6796g

	5pc	10; 13; 17; 19; 24 mm
	3pc	Thin-wall 17; 19; 21 mm (85mmL)
	5pc	15; 17; 19; 21; 23 mm (85mmL)
	1pc	Ratchet impact wrench Max. 108 Nm (82443)
	1pc	Impact wrench Max. 1566 Nm (825410)
	1pc	Ball type 5" (125mm)
	1pc	Ball type 1/2"
	2pc	Pin 20L-Ø3.0; 25L-Ø3.0
	2pc	Ring Ø19-Ø3.5; Ø24-Ø3.5

15pc Impact accessory set

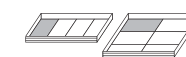

T8151

6/17.6/18.6/0.78' 2933g

	8pc	Ball type 1/4"(F)x3/8"(M); 3/8"(F)x1/4"(M); 3/8"(F)x1/2"(M); 1/2"(F)x3/8"(M); 1/2"(F)x3/4"(M); 3/4"(F)x1/2"(M); 3/4"(F)x1"(M); 1"(F)x3/4"(M)
	3pc	Ball type 3/8"DR.; 1/2"DR.; 3/4"DR.
	4pc	3/8"DR.x1/4"(F); 3/8"DR.x5/16"(F); 1/2"DR.x1/4"(F); 1/2"DR.x5/16"(F)

8pc Flare nut wrench set

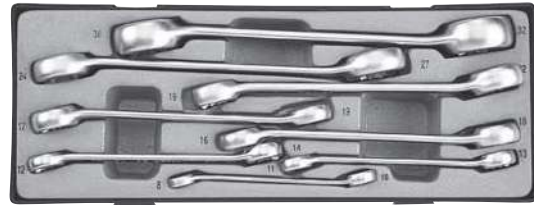

T5082

6/11.9/12.9/0.78' 1980g

	8pc	8x10; 11x13; 12x14; 16x18; 17x19; 19x22; 24x27; 30x32 mm
---	-----	---

7pc Flare nut wrench set (SAE)

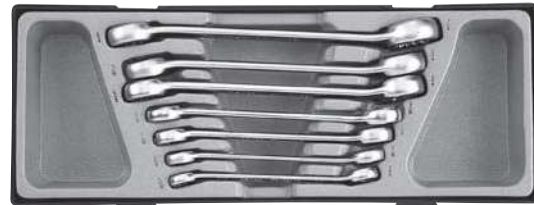
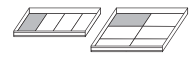

T50710

6/7.2/8.2/0.72' 1200g

	7pc	5/16"x3/8"; 3/8"x7/16"; 7/16"x1/2"; 1/2"x9/16"; 5/8"x3/4"; 11/16"x3/4"; 3/4"x7/8"
---	-----	--

9pc Ratchet flare nut wrench set

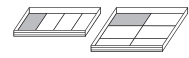

T50918

6/8.1/9.1/0.65' 1350g

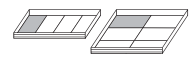

	9pc	8; 10; 11; 12; 13; 14; 17; 19; 22 mm
---	-----	--------------------------------------

17pc Crowfoot flare nut wrench set



T5172

6/10.4/11.4/0.65' 1730g



	12pc	3/8"DR. 10; 11; 12; 13; 14; 15; 16; 17; 18; 19; 21; 22 mm
	3pc	1/2"DR. 23; 24; 26 mm
	2pc	Locking 3/8"DR. 6"(150mm); 1/2"DR. 5"(125mm)

13pc Crowfoot flare nut wrench set (SAE)



T5135S

6/8.6/9.2/0.65' 1430g

	9pc	3/8"DR. 3/8"; 7/16"; 1/2"; 9/16"; 5/8"; 11/16"; 3/4"; 13/16"; 7/8"
	2pc	1/2"DR. 15/16"; 1"
	2pc	Locking 3/8"DR. 6"(150mm); 1/2"DR. 5"(125mm)

7pc Hinged socket wrench set

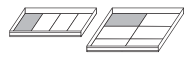

T5074

6/9.6/10.6/0.65' 1600g

	7pc	6x7; 8x9; 10x11; 12x13; 14x15; 16x17; 18x19 mm
---	-----	--

3pc Hinged socket wrench set

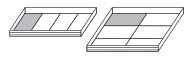

T5033

6/12.0/13.0/0.65' 2000g

	3pc	20x22; 21x23; 24x27 mm
---	-----	------------------------

6pc Hinged socket wrench set (SAE)

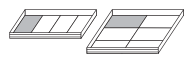



T50616S

6/15.2/16.2/0.65' 2530g

	6pc	3/8"x7/16"; 1/2"x9/16"; 5/8"x11/16"; 3/4"x7/8"; 13/16"x7/8"; 15/16"x1"
---	-----	---

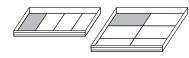
7pc Hinged star socket wrench set





T5075  6/8.5/9.5/0.65'  1417g

 7pc	E4xE5; E6xE7; E8xE10; E11xE12; E14xE16; E18xE20; E22xE24
---	--

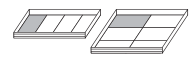
11pc Angle 6pt.-6pt. socket wrench set





T5114  6/16.5/17.5/0.78'  2750g

 11pc	8; 10; 11; 12; 13; 14; 15; 16; 17; 18; 19 mm
--	--

11pc Double open end wrench set





T5111  6/11.8/12.8/0.78'  1960g

 11pc	6x7; 8x9; 10x11; 12x13; 14x15; 16x17; 18x19; 20x22; 21x23; 24x27; 30x32 mm
--	--

11pc Double open end wrench set (SAE)





T5111S  6/13.0/14.0/0.78'  2160g

 11pc	1/4"x5/16"; 5/16"x3/8"; 3/8"x7/16"; 1/2"x9/16"; 9/16"x5/8"; 5/8"x11/16"; 11/16"x3/4"; 13/16"x7/8"; 15/16"x1"; 15/16"x1-1/16"; 1-1/8"x1-1/4"
--	---

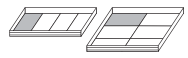
16pc Combination wrench set





T5161  6/11.1/12.1/0.65'  1850g

 16pc	6; 7; 8; 9; 10; 11; 12; 13; 14; 15; 16; 17; 18; 19; 22; 24 mm
--	---

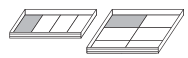
5pc Combination wrench set





T5052  6/16.3/17.3/0.78'  2717g

 5pc	26; 27; 28; 30; 32 mm
---	-----------------------

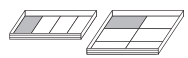
18pc Combination wrench set





T5181  6/12.9/13.9/0.78'  2150g

 18pc	6; 7; 8; 9; 10; 11; 12; 13; 14; 15; 16; 17; 18; 19; 20; 21; 22; 23 mm
--	---

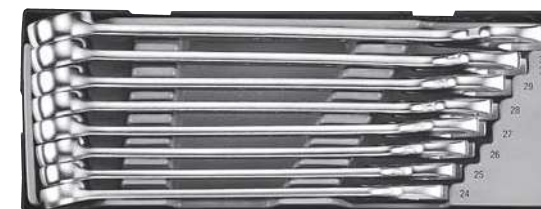
8pc Combination wrench set





T5089  6/23.2/24.2/0.85'  3867g

 8pc	24; 25; 26; 27; 28; 29; 30; 32 mm
---	-----------------------------------

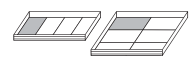
13pc Combination wrench set (SAE)





T5134  13pc  6/13.1/14.1/0.65'  2183g

1/4"; 5/16"; 3/8"; 7/16"; 1/2"; 9/16"; 5/8"; 11/16"; 3/4"; 13/16"; 7/8"; 15/16"; 1"
--

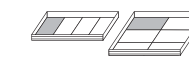
8pc 75° Offset ring wrench set





T5081  8pc  6/9.3/10.3/0.65'  1550g

6x7; 8x9; 10x11; 12x13; 14x15; 16x17; 18x19; 21x23 mm
--

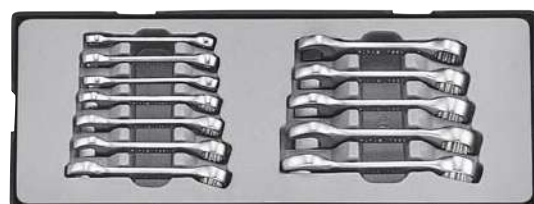
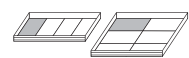
12pc Midget combination wrench set





T51214  12pc  6/6.0/7.0/0.65'  1000g

8; 9; 10; 11; 12; 13; 14; 15; 16; 17; 18; 19 mm

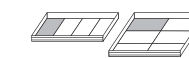
4pc 75° Offset ring wrench set





T5044  4pc  6/13.4/14.4/0.72'  2233g

23x26; 24x27; 25x28; 30x32 mm

8pc 45° Offset ring wrench set





T5085  8pc  6/9.5/10.5/0.65'  1583g

8x9; 10x11; 12x13; 14x15; 16x17; 18x19; 21x23; 22x24 mm
--

8pc 75° Offset ring wrench set (SAE)





T5081S  8pc  6/9.3/10.3/0.65'  1550g

1/4"x5/16"; 3/8"x7/16"; 1/2"x9/16"; 5/8"x11/16"; 5/8"x3/4"; 3/4"x7/8"; 13/16"x7/8"; 15/16"x1"
--

8pc 45° Offset ring wrench set (SAE)





T5085S  8pc  6/9.8/10.8/0.65'  1630g

1/4"x5/16"; 3/8"x7/16"; 7/16"x1/2"; 1/2"x9/16"; 5/8"x11/16"; 11/16"x3/4"; 13/16"x7/8"; 7/8"x15/16"
--

12pc Flat ring wrench set



T51226  12pc  6/14.0/15.0/0.72'  2333g

6x7; 8x9; 10x11; 12x13; 14x15; 16x17; 18x19; 20x22; 21x23; 22x24; 26x28; 30x32 mm
--

12pc 15° Offset ring wrench set

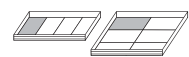

T51226A 6/14.2/15.2/0.72' 2360g

12pc	6x7; 8x9; 10x11; 12x13; 14x15; 16x17; 18x19; 20x22; 21x23; 22x24; 26x28; 30x32 mm
------	---

9pc Half-moon ring wrench set

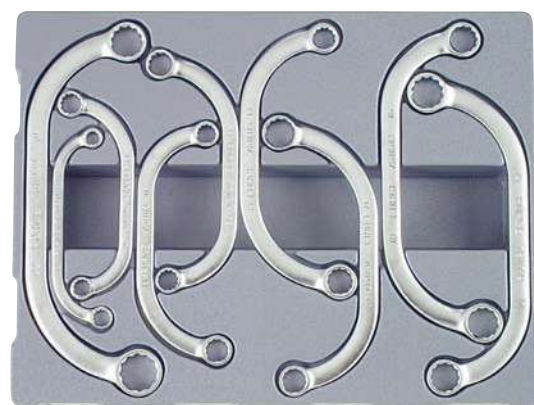

50911 6/8.3/9.3/1.3' 1380g

9pc	8x10; 10x12; 11x13; 12x14; 13x15; 14x17; 16x18; 17x19; 19x22 mm
-----	---

6pc S-form ring wrench set



T50634 6/7.3/8.3/0.65' 1216g

6pc	10x12; 11x13; 14x15; 16x18; 17x19; 22x24 mm
-----	---

8pc Double ended 6pt.-6pt. socket wrench set



T50817 6/7.0/8.0/0.65' 1160g

7pc	6x7; 8x9; 10x11; 12x13; 14x15; 16x17; 18x19 mm
1pc	220 mm

12pc Flat ratchet wrench set

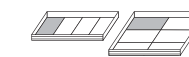

T51210 6/9.6/10.6/0.65' 1600g

12pc	8; 9; 10; 11; 12; 13; 14; 15; 16; 17; 18; 19 mm
------	---

16pc Flat ratchet wrench & adapter set

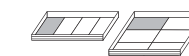

T5164 6/10.7/11.7/0.65' 1790g

12pc	8; 9; 10; 11; 12; 13; 14; 15; 16; 17; 18; 19 mm
3pc	10mmx1/4"DR.; 13mmx3/8"DR.; 19mmx1/2"DR.
1pc	10mmx1/4"inhex

8pc Flat ratchet wrench set (SAE)

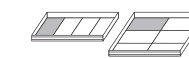

T50812 6/7.0/8.0/0.65' 1160g

8pc	5/16"; 3/8"; 7/16"; 1/2"; 9/16"; 5/8"; 11/16"; 3/4"
-----	---

12pc Flat ratchet wrench & adapter set (SAE)





T51215 6/7.6/8.6/0.65' 1260g

8pc	5/16"; 3/8"; 7/16"; 1/2"; 9/16"; 5/8"; 11/16"; 3/4"
3pc	3/8"x1/4"DR.; 1/2"x3/8"DR.; 3/4"x1/2"DR.
1pc	3/8"x1/4"inhex

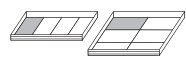
12pc Reversible ratchet wrench set





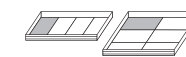

T51211  6/10.2/11.2/0.65'  1700g

	12pc	8; 9; 10; 11; 12; 13; 14; 15; 16; 17; 18; 19 mm
---	------	---

13pc Flat ratchet wrench & flare nut wrench set





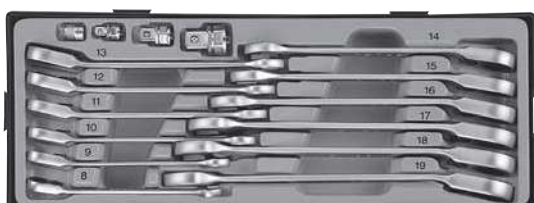

T51315  6/9.4/10.4/0.72'  1567g

	7pc	8; 10; 12; 13; 14; 17; 19 mm
	6pc	8x10; 9x11; 10x12; 11x13; 12x14; 17x19 mm

16pc Reversible ratchet wrench & adapter set





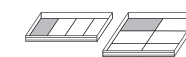

T5164R  6/10.7/11.7/0.65'  1790g

	12pc	8; 9; 10; 11; 12; 13; 14; 15; 16; 17; 18; 19 mm
	3pc	10mmx1/4"DR.; 13mmx3/8"DR.; 19mmx1/2"DR.
	1pc	10mmx1/4"inhex

11pc Flat ratchet combination & star wrench set





T51115  6/9.0/10.0/0.78'  1500g

	7pc	8; 10; 12; 13; 14; 17; 19 mm
	4pc	E6xE8; E10xE12; E14xE18; E20xE24

8pc Flat ratchet ring wrench set





T50810  6/9.3/10.3/0.65'  1550g

	8pc	6x7; 8x9; 10x11; 12x13; 14x15; 16x18; 17x19; 21x22 mm
---	-----	---

8pc Reversible ratchet wrench set (SAE)





T50813  6/7.3/8.3/0.65'  1210g

	8pc	5/16"; 3/8"; 7/16"; 1/2"; 9/16"; 5/8"; 11/16"; 3/4"
---	-----	---

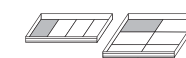
8pc 15° Offset ratchet ring wrench set







T50811  6/8.8/9.8/0.72'  1460g

	8pc	6x7; 8x9; 10x11; 12x13; 14x15; 16x18; 17x19; 21x22 mm
---	-----	---

12pc Reversible ratchet wrench & adapter set (SAE)





T51215R  6/7.6/8.6/0.65'  1260g

	8pc	5/16"; 3/8"; 7/16"; 1/2"; 9/16"; 5/8"; 11/16"; 3/4"
	3pc	3/8"x1/4"DR.; 1/2"x3/8"DR.; 3/4"x1/2"DR.
	1pc	3/8"x1/4"inhex

6pc 15° Offset ratchet star wrench set



T50617  6/8.0/9.0/0.72'  1330g

	6pc	E6xE7; E8xE10; E11xE12; E14xE16; E18xE20; E22xE24
---	-----	---

2pc Pliers set

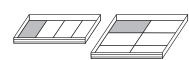

T5021

6/7.2/8.2/0.65' 1200g

	1pc	613250	Waterpump pliers 10"(250mm)
	1pc	614250	Locking pliers 10"(250mm)

3pc Adjustable gauged wrench set

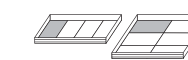

T5036A

6/8.6/9.6/0.65' 1430g

	1pc	649200A	Adjustable gauged wrench 8"(200mm)
	1pc	649250A	Adjustable gauged wrench 10"(250mm)
	1pc	649300A	Adjustable gauged wrench 12"(300mm)

3pc Pliers set

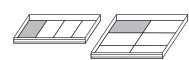

T5038

6/9.1/10.1/0.65' 1517g

	1pc	613B250	Waterpump pliers 10"(250mm)
	1pc	614250	Locking pliers 10"(250mm)
	1pc	649250A	Adjustable gauged wrench 10"(250mm)

3pc Pliers set

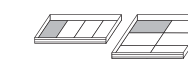

T5034

6/5.9/6.9/0.65' 983g

	1pc	610200	Long nose pliers 8"(200mm)
	1pc	611215	Combination pliers 8.5"(215mm)
	1pc	612175	Diagonal pliers 7"(175mm)

2pc Adjustable gauged wrench set

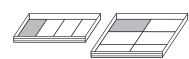

T5023

6/6.8/7.8/0.65' 1130g

	1pc	649200E	Adjustable gauged wrench 8"(200mm)
	1pc	649300E	Adjustable gauged wrench 12"(300mm)

4pc Pliers set

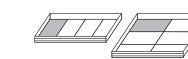

T5045

6/7.9/8.9/0.65' 1317g

	1pc	610B200	Long nose pliers 8"(200mm)
	1pc	611B175	Combination pliers 7"(175mm)
	1pc	612B175	Diagonal pliers 7"(175mm)
	1pc	673B215	Slip joint pliers 8.5"(215mm)

3pc Adjustable gauged wrench set



T5036

6/9.9/10.9/0.65' 1650g

	1pc	649200	Adjustable gauged wrench 8"(200mm)
	1pc	649250	Adjustable gauged wrench 10"(250mm)
	1pc	649300	Adjustable gauged wrench 12"(300mm)

4pc Pliers set

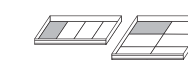

T5046

6/7.6/8.6/0.65' 1267g

	1pc	610B200	Long nose pliers 8"(200mm)
	1pc	610B200B	Bent long nose pliers 8"(200mm)
	1pc	611B175	Combination pliers 7"(175mm)
	1pc	612B175	Diagonal pliers 7"(175mm)

4pc Insulated pliers set

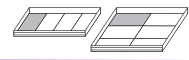

T50410

6/7.0/8.0/0.65' 1167g

	1pc	6903180	Insulated combination pliers 7"(180mm)
	1pc	6904160	Insulated long nose pliers 6.3"(160mm)
	1pc	6911200	Insulated diagonal pliers 8"(200mm)
	1pc	6912160	Insulated wire stripper pliers 6.3"(160mm)

4pc Snap ring pliers set

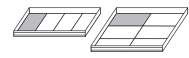

T5043A

6/4.7/5.7/0.65' 780g

	1pc	609ABC	Internal 90° bent 7"(180mm)
	1pc	609ABO	External 90° bent 7"(180mm)
	1pc	609ASC	Internal straight 7"(180mm)
	1pc	609ASO	External straight 7"(180mm)

4pc Pliers set

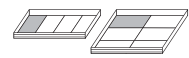

T5047

6/9.6/10.6/0.65' 1600g

	1pc	5047P1	Long nose straight pliers 11"(280mm)
	1pc	5047P2	Long nose 45° pliers 11"(280mm)
	1pc	5047P3	Long nose 90° pliers 11"(280mm)
	1pc	5047P4	Multi-purpose 4 points gripping pliers 11"(280mm)

5pc Multi-grip pliers set



T5057

6/16.4/17.4/0.86' 2733g

	1pc	67901	Wide flat jaw
	1pc	67902	Double curved jaw
	1pc	67903	Wide curved jaw
	1pc	67904	Angled jaw
	1pc	67905	Straight jaw

8pc Mini pliers set

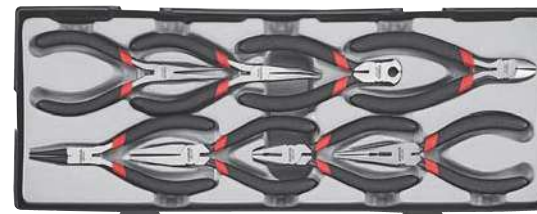
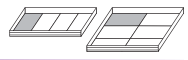

T50814

6/4.4/5.4/0.65' 730g

	1pc	50814P1	Round nose pliers 5"(125mm)
	1pc	50814P2	Flat nose pliers 5"(125mm)
	1pc	50814P3	Combination pliers 5"(125mm)
	1pc	50814P4	Long nose pliers 5"(125mm)
	1pc	50814P5	Needle nose pliers 6"(150mm)
	1pc	50814P6	Bent nose pliers 6"(150mm)
	1pc	50814P7	Cutter pliers 6"(150mm)
	1pc	50814P8	Diagonal pliers 6"(150mm)

4pc Terminal & stripper pliers set

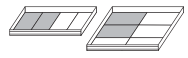

5048

6/12.7/13.7/1.2' 2116g

	1pc	6801	Terminal pliers red, blue, yellow
	1pc	6802	Terminal pliers 0.5; 0.75; 1.0; 1.5; 2.5; 4
	1pc	6803	Terminal pliers 0.5-1; 1.1-2.5; 4-6
	1pc	6804	Stripper pliers

5pc Hammer and chisel set

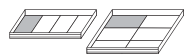

T5053

6/11.6/12.6/0.72' 1930g

	1pc	60215180	Chisel 15 (180mmL)
	1pc	60219200	Chisel 19 (200mmL)
	1pc	60225220	Chisel 25 (220mmL)
	1pc	616300	Engineer hammer 300gw
	1pc	616400	Rubber hammer 400gw (280mmL)

5pc Hammer and chisel set



T5053A

6/12.1/13.1/0.72' 2017g

	1pc	60215180	Chisel 15 (180mmL)
	1pc	60219200	Chisel 19 (200mmL)
	1pc	60225220	Chisel 25 (220mmL)
	1pc	616300	Engineer hammer 300gw
	1pc	616A400	Soft face hammer 400gw

5pc Hammer and chisel set

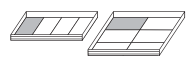

T5053F 6/13.4/14.4/0.72' 2232g

	1pc	60215180	Chisel 15 (180mmL)
	1pc	60219200	Chisel 19 (200mmL)
	1pc	60225220	Chisel 25 (220mmL)
	1pc	616F032	Riveting hammer 32mm
	1pc	616400	Rubber hammer 400gw (280mmL)

5pc Hammer and chisel set



T5053AF 6/13.4/14.4/0.72' 2232g

	1pc	60215180	Chisel 15 (180mmL)
	1pc	60219200	Chisel 19 (200mmL)
	1pc	60225220	Chisel 25 (220mmL)
	1pc	616F032	Riveting hammer 32mm
	1pc	616A400	Soft face hammer 400gw

6pc Hammer, chisel and punch set



T50633AF 6/11.0/12.0/0.72' 1830g

	1pc	60226200C	Ribbed chisel 26 (200mmL)
	1pc	6044190	Pin punch 4 (190mmL)
	1pc	6046210	Pin punch 6 (210mmL)
	1pc	6074185	Center punch 4 (185mmL)
	1pc	616F032	Riveting hammer 32mm
	1pc	616A400	Soft face hammer 400gw

8pc Hammer, chisel and punch set



T50822 6/9.5/10.5/0.65' 1583g

	1pc	60212150	Chisel 12 (150mmL)
	1pc	603150	Cape chisel (150mmL)
	1pc	6044190	Pin punch 4 (190mmL)
	1pc	6063185	Taper punch 3 (185mmL)
	1pc	6074185	Center punch 4 (185mmL)
	1pc	616500	Engineer hammer 500gw
	1pc	618	Feeler gauges of 20 sizes
	1pc	905M2P3	Gasket scraper

12pc Chisel and punch set

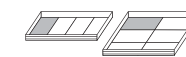

NEW



T51229 6/10.1/11.1/0.65' 1683g

	1pc	60212150	Chisel 12 (150mmL)
	1pc	60215180	Chisel 15 (180mmL)
	1pc	60222200	Chisel 22 (200mmL)
	1pc	603150	Cape chisel (150mmL)
	1pc	6042140	Pin punch 2 (140mmL)
	1pc	6043150	Pin punch 3 (150mmL)
	1pc	6044190	Pin punch 4 (190mmL)
	1pc	6045200	Pin punch 5 (200mmL)
	1pc	6046210	Pin punch 6 (210mmL)
	1pc	6048215	Pin punch 8 (215mmL)
	1pc	60410230	Pin punch 10 (230mmL)
	1pc	6074185	Center punch 4 (185mmL)

13pc Chisel and punch set

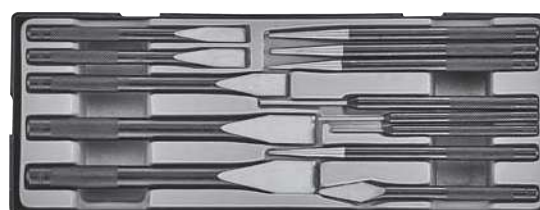

T5131 6/10.1/11.1/0.65' 1680g

	1pc	60210150	Chisel 10 (150mmL)
	1pc	60212150	Chisel 12 (150mmL)
	1pc	60215180	Chisel 15 (180mmL)
	1pc	60219200	Chisel 19 (200mmL)
	1pc	60222200	Chisel 22 (200mmL)
	1pc	603150	Cape chisel (150mmL)
	1pc	6042140	Pin punch 2 (140mmL)
	1pc	6043150	Pin punch 3 (150mmL)
	1pc	6044190	Pin punch 4 (190mmL)
	1pc	6062185	Taper punch 2 (185mmL)
	1pc	6063185	Taper punch 3 (185mmL)
	1pc	6064185	Taper punch 4 (185mmL)
	1pc	6074185	Center punch 4 (185mmL)

7pc Quakeproof punch set

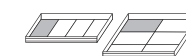

NEW



T50723A 6/6.0/7.0/0.78' 1000g

	1pc	6042140Q	Pin punch 2 (140mmL)
	1pc	6043150Q	Pin punch 3 (150mmL)
	1pc	6044190Q	Pin punch 4 (190mmL)
	1pc	6045200Q	Pin punch 5 (200mmL)
	1pc	6046210Q	Pin punch 6 (210mmL)
	1pc	6048215Q	Pin punch 8 (215mmL)
	1pc	6074185Q	Center punch 4 (185mmL)

13pc Quakeproof punch set

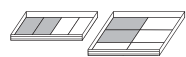

5138

6/14.6/15.6/1.5' 2430g

1pc	6042140Q	Pin punch 2 (140mmL)
1pc	6043150Q	Pin punch 3 (150mmL)
1pc	6044190Q	Pin punch 4 (190mmL)
1pc	6045200Q	Pin punch 5 (200mmL)
1pc	6046210Q	Pin punch 6 (210mmL)
1pc	6048215Q	Pin punch 8 (215mmL)
1pc	60410230Q	Pin punch 10 (230mmL)
1pc	60412280Q	Pin punch 12 (280mmL)
1pc	60414290Q	Pin punch 14 (290mmL)
1pc	6064185Q	Taper punch 4 (185mmL)
1pc	6065185Q	Taper punch 5 (185mmL)
1pc	6066185Q	Taper punch 6 (185mmL)
1pc	6076185Q	Center punch 6 (185mmL)

7pc Quakeproof chisel set



T50725

6/10.6/11.6/0.78' 1760g

1pc	60210150Q	Chisel 10 (150mmL)
1pc	60212150Q	Chisel 12 (150mmL)
1pc	60215180Q	Chisel 15 (180mmL)
1pc	60219200Q	Chisel 19 (200mmL)
1pc	60222200Q	Chisel 22 (200mmL)
1pc	60225220Q	Chisel 25 (220mmL)
1pc	603150Q	Cape chisel (150mmL)

13pc Quakeproof chisel and punch set

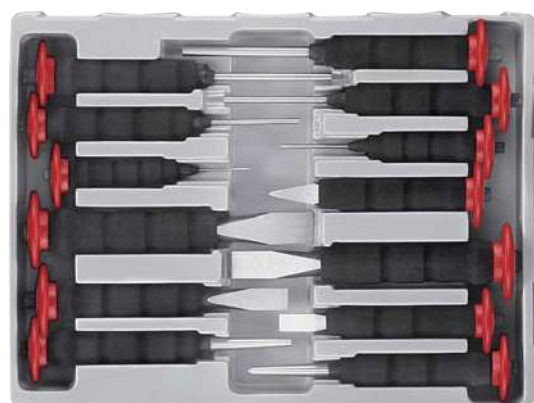

5139

6/12.5/13.5/1.5' 2080g

1pc	60212150Q	Chisel 12 (150mmL)
1pc	60215180Q	Chisel 15 (180mmL)
1pc	60219200Q	Chisel 19 (200mmL)
1pc	60222200Q	Chisel 22 (200mmL)
1pc	603150Q	Cape chisel 3 (150mmL)
1pc	6042140Q	Pin punch 2 (140mmL)
1pc	6043150Q	Pin punch 3 (150mmL)
1pc	6044190Q	Pin punch 4 (190mmL)
1pc	6045200Q	Pin punch 5 (200mmL)
1pc	6046210Q	Pin punch 6 (210mmL)
1pc	6048215Q	Pin punch 8 (215mmL)
1pc	6066185Q	Taper punch 6 (185mmL)
1pc	6076185Q	Center punch 6 (185mmL)

5pc Cutting tool set

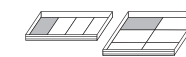

T5055

6/6.7/7.7/0.65' 1117g

1pc	5055P1	Straight shears
1pc	5055P4	Utility knife (include 3pc blades)
1pc	66302	Mini hacksaw frame 6"
2pc	5055P3	Saw blade

5pc File set

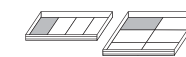

T5056

6/6.2/7.2/0.65' 1030g

1pc	5056P1	8"(200mm) Flat file
1pc	5056P2	8"(200mm) Half-round file
1pc	5056P3	8"(200mm) Round file
1pc	5056P4	8"(200mm) Square file
1pc	5056P5	8"(200mm) Triangular file

9pc Measuring tool set



T5096

6/5.3/6.3/0.65' 883g

1pc	5096P1	Steel vernier caliper
1pc	5096P2	Auto center punch
1pc	5096P3	Stainless steel straight ruler 30cm
1pc	5096P4	Stainless steel protractor
1pc	5096P5	Screw pitch gauges 0.25-6 (MM)
1pc	5096P6	Screw pitch gauges 4-62 (SAE)
1pc	5096P7	Steel scriber
1pc	5096P8	5m measuring tape
1pc	61802	Feeler gauges of 26 sizes (SAE & MM)

33pc Screw repair tool set

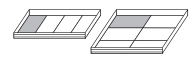

T5331

6/14.9/15.9/0.72' 2480g

	2pc	5/16" PH.2; PH.3 (36mmL)
	2pc	5/16" PH.2; PH.3 (80mmL)
	2pc	5/16" PZ.2; PZ.3 (36mmL)
	2pc	5/16" 9; 11 mm (36mmL)
	2pc	5/16" 9; 11 mm (80mmL)
	3pc	5/16" 6; 8; 10 mm (36mmL)
	5pc	5/16" T25; T30; T40; T45; T50 (35mmL)
	1pc	1/2"DR. Impact driver (8174)
	1pc	5/16"Hex-3/8"Sq.
	1pc	1/2"DR.x5/16"(F)
	1pc	Nut splitter 5/16"-1/2" (9-12mm) (6720912)
	1pc	Nut splitter 1/2"-5/8" (12-16mm) (6721216)
	1pc	Nut splitter 5/8"-7/8" (16-22mm) (6721622)
	4pc	Stud extractor 6; 8; 10; 12 mm (818 06...12)

	5pc	Screw extractor 1/8"(M3) to 1/4"(M6); 1/4"(M6) to 5/16"(M8); 5/16"(M8) to 7/16"(M11); 7/16"(M11) to 9/16"(M14); 9/16"(M14) to 3/4"(M18) (63005)
--	-----	--

12pc Auto tool kit



T5122

6/10.1/11.1/0.65' 1683g

	1pc	807416M	1/2"DR. Magnetic spark plug 16mm
	1pc	807420.6M	1/2"DR. Magnetic spark plug 20.6mm
	1pc	5061-1	Plug key 5/16"Hex - 3/8"Hex
	1pc	5061-2	Plug key 8mmSq. - 3/8"Sq.
	1pc	5061-3	Plug key 11mmSq. - 12mmHex
	1pc	5061-4	Plug key 13mmSq. - 14mmHex
	1pc	5061-5	Plug key 17mmHex - 12"Hex
	1pc	5061-6	Plug key 8mmHex - 10mmHex
	1pc	810421	Plug key holder 1/2"(F)x21mm(F)
	1pc	617	Telescope mirror stick/magnetic pick-up
	1pc	618	Feeler gauges of 20 sizes
	1pc	619	Oil filter strap wrench

10pc 3/8"DR. Spark plug socket set

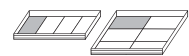

NEW



T31010

6/13.2/14.2/0.65' 2200g

	4pc	Magnetic spark plug 14; 16; 18; 20.6 mm
	3pc	Magnetic spark plug 14; 16; 20.6 mm (250mmL)
	2pc	Torque adaptor 18Nm; 24Nm (8323 18...24)
	1pc	Universal joint - extension type (80531E)

6pc 3/8"DR. Spark plug combination set

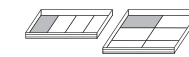

T50618-18

6/12.6/13.6/0.65' 2100g

	2pc	Magnetic spark plug 16; 20.6 mm
	2pc	Magnetic spark plug 16; 20.6 mm (250mmL)
	1pc	Pre-set 18Nm, 245mmL (647318P)
	1pc	11"(280mm)

T50618-24

6/12.6/13.6/0.65' 2100g

Changed items		
	1pc	Pre-set 24Nm, 245mmL (647324P)

86pc Grade nut fastener set

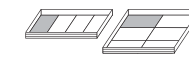

T5861

6/5.7/6.7/0.72' 950g

67802	1pc	Grade nut fastener (include 1pc M6x1.0 screw)
5861-M3...M5	3pc	Screw M3x0.5; M4x0.7; M5x0.8
5861-S	1pc	Spanner
5861-1	20pc	Instant blind nut 5.1mm
5861-2	20pc	Instant blind nut 6.1mm
5861-3	20pc	Instant blind nut 7.1mm
5861-4	20pc	Instant blind nut 9.1mm

181pc Rivet pliers set



T51811

6/8.4/9.4/0.72' 1400g

67801	1pc	Rivet pliers
51811-1	30pc	Aluminum rivet 4x8
51811-2	30pc	Aluminum rivet 4x10
51811-3	30pc	Aluminum rivet 4.8x8
51811-4	30pc	Aluminum rivet 4.8x10
51811-5	30pc	Stainless rivet 4x7
51811-6	30pc	Stainless rivet 4x10

411pc Tie tape pliers kit

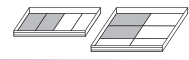

54111

6/5.0/6.0/1.2' 833g

54111P1	1pc	Tie down pliers
54111P2	100pc	Tie tape 2.5x102mmL
54111P3	100pc	Tie tape 3.2x150mmL
54111P4	100pc	Tie tape 3.6x182mmL
54111P5	100pc	Tie tape 4.8x200mmL
54111P6	10pc	Two-way baseplate

5pc Auto body tool set



T905M2

6/5.0/6.0/0.65' 833g

	1pc	905M2P1	Trim pad remover (big)
	1pc	905M2P2	Trim pad remover (small)
	1pc	905M2P3	Gasket scraper
	1pc	905M2P4	Radiator hose remover
	1pc	905M2P5	Cotter pin puller

7pc Auto body repair tool set

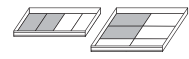

50713

3/18.7/19.7/0.9' 6230g

	1pc	62602	Pick & finishing hammer
	1pc	62603	Light shrinking hammer
	1pc	62604	Standard bumping hammer
	1pc	68301	Utility dolly
	1pc	68302	Curved dolly
	1pc	68303	Heel dolly
	1pc	68304	Toe dolly

6pc Wheel special tool set

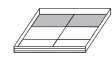

50619

3/14.7/15.7/0.76' 4900g

	3pc	1/2"DR. 17; 19; 21 mm (85mmL)
	1pc	1/2"DR. 40-210 Nm, 535mmL (6474535)
	1pc	Foldable cross-handle socket wrench 17; 19; 21mm; 1/2" square (500mmL) (681500)
	1pc	Wheel balancing weight tool 10" (245mmL) (6821)

9pc T-handle hex key set

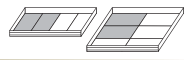

2097

6/7.5/8.5/1.3' 1250g

	9pc	2; 2.5; 3; 4; 5; 6; 7; 8; 10 mm
--	-----	---------------------------------

2097S

6/7.7/8.7/1.3' 1283g

	9pc	3/32"; 7/64"; 1/8"; 5/32"; 3/16"; 7/32"; 1/4"; 5/16"; 3/8"
--	-----	--

9pc T-handle hex ball point key set

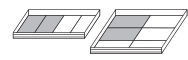

2097B

6/7.0/8.0/1.3' 1166g

	9pc	2; 2.5; 3; 4; 5; 6; 7; 8; 10 mm
--	-----	---------------------------------

14pc T-handle star key set



2141

6/9.3/10.3/1.8' 1550g

	14pc	T6; T7; T8; T9; T10; T15; T20; T25; T27; T30; T40; T45; T50; T55
--	------	--

14pc T-handle star tamperproof key set

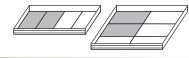

2141T

6/9.2/10.2/1.8' 1533g

14pc	T-6H; T-7H; T-8H; T-9H; T-10H; T-15H;
	T-20H; T-25H; T-27H; T-30H; T-40H; T-45H;
	T-50H; T-55H

6pc Hex & hex ball point grip key set

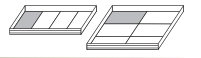

T50637

6/3.4/4.4/0.65' 566g

6pc	2; 3; 4; 5; 6; 8 mm
-----	---------------------

9pc T-handle hex socket driver set



2095

6/11.7/12.7/1.8' 1950g

9pc	5; 6; 7; 8; 9; 10; 11; 12; 13 mm (300mmL)
-----	---

2095S

6/10.5/11.5/1.8' 1750g

9pc	3/16"; 1/4"; 9/32"; 5/16"; 11/32"; 3/8"; 7/16";
	1/2"; 9/16" (300mmL)

10pc Hex & hex ball point grip key set

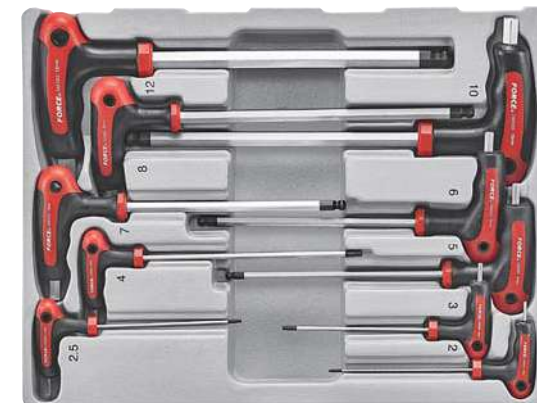

5106B

6/8.2/9.2/1.3' 1366g

10pc	2; 2.5; 3; 4; 5; 6; 7; 8; 10; 12 mm
------	-------------------------------------

9pc T-handle star socket driver set



2096

6/10.5/11.5/1.8' 1750g

9pc	E4; E5; E6; E7; E8; E10; E12; E14; E16 (260mmL)
-----	---

9pc Hex & hex ball point grip key set (SAE)

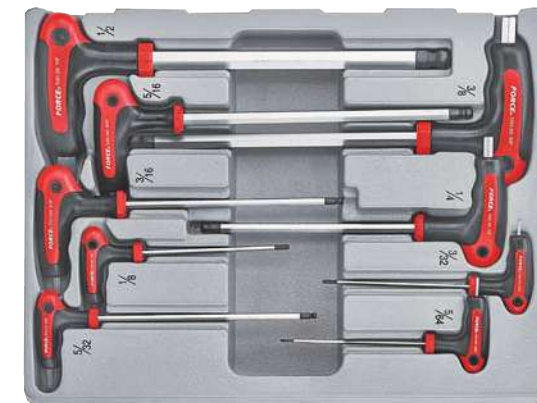
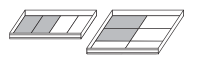

50910BS

6/7.7/8.7/1.3' 1283g

9pc	5/64"; 3/32"; 1/8"; 5/32"; 3/16"; 1/4"; 5/16";
	3/8"; 1/2"

6pc Star & star tamperproof grip key set

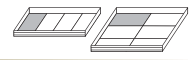

NEW



T50636

6/3.4/4.4/0.65' 570g

	6pc	T10xT-10H; T15xT-15H; T20xT-20H; T25xT-25H; T27xT-27H; T30xT-30H
--	-----	---

9pc Adjustable 3-way T-shaped hex key set

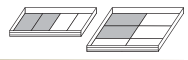

50919

6/10.1/11.1/1.3' 1683g

	9pc	2; 2.5; 3; 4; 5; 6; 8; 10; 12 mm
--	-----	----------------------------------

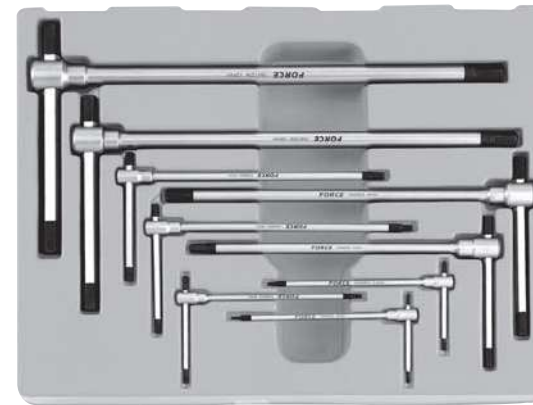

10pc Star & star tamperproof grip key set

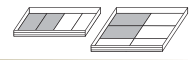

51010T

6/9.2/10.2/1.3' 1533g

	10pc	T10xT-10H; T15xT-15H; T20xT-20H; T25xT-25H; T27xT-27H; T30xT-30H; T40xT-40H; T45xT-45H; T50xT-50H; T55xT-55H
--	------	---

8pc Long universal socket driver set



50816

6/24.2/25.2/2.8' 4030g

	8pc	1/4"DR. 7; 8 mm (400mmL) 3/8"DR. 10; 12; 13 mm (450mmL); 14; 17 mm (500mmL) 1/2"DR. 19 mm (500mmL)
--	-----	---

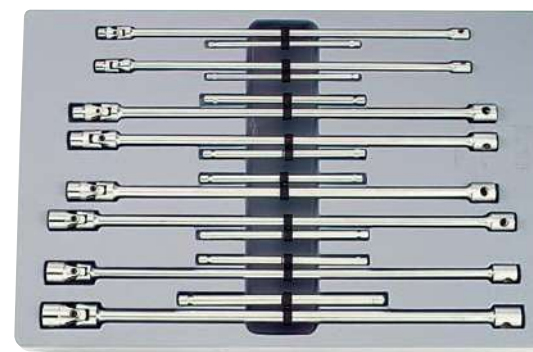

9pc 3-Way T-shaped hex key set

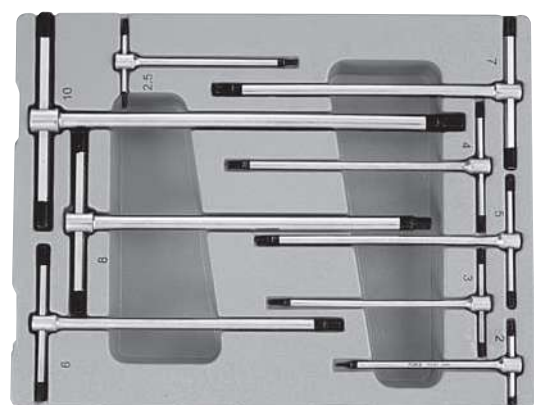

50912

6/7.9/8.9/1.3' 1317g

	9pc	2; 2.5; 3; 4; 5; 6; 7; 8; 10 mm
--	-----	---------------------------------



NO.2208

20pc Screwdriver & pliers set

- 2pc Phillips stubby screwdriver PH.1; PH.2 (25mmL)
- 3pc Phillips screwdriver PH.1 (80mmL); PH.2 (100mmL); PH.3 (150mmL)
- 2pc Slotted stubby screwdriver 5.5; 6.5 mm (25mmL)
- 6pc Slotted screwdriver 3mm (75mmL); 3.5mm (100mmL); 4mm (100mmL); 5.5mm (125mmL); 6.5mm (150mmL); 8mm (175mmL)
- 1pc Long nose pliers 8"(200mm)
- 1pc Combination pliers 7"(175mm)
- 1pc Diagonal pliers 7"(175mm)
- 1pc Waterpump pliers 10"(250mm)
- 1pc Locking pliers 10"(250mm)
- 1pc Adjustable gauged wrench 10"(250mm)
- 1pc Demagnetizer / Magnetizer



NO.41432

143pc 1/4" & 3/8" & 1/2" Socket combination set

- 1/4"DR. Part
- 12pc 6pt. Flank socket 4; 4.5; 5; 5.5; 6; 7; 8; 9; 10; 11; 12; 13 mm
- 34pc Socket bit (32mmL)
 - Phillips PH.0; PH.1; PH.2; PH.3
 - Pozidriv PZ.0; PZ.1; PZ.2; PZ.3
 - Slotted 4; 5.5; 6.5; 7 mm
 - Hex 3; 4; 5; 6; 7; 8 mm
 - Star T8; T10; T15; T20; T25; T27; T30; T40
 - Star tamperproof T-8H; T-10H; T-15H; T-20H; T-25H; T-27H; T-30H; T-40H
- 1pc Quick-release pear ratchet handle 72teeth (80228)
- 3pc Extension 2"(50mm); 4"(100mm); 6"(150mm)
- 1pc Universal joint
- 1pc Adaptor for extension 3/8"(F)x1/4"(M)
- 1pc Spinner 6"(150mm) with 1/4"DR.(F)

- 3/8"DR. Part
- 15pc 6pt. Flank socket 8; 9; 10; 11; 12; 13; 14; 15; 16; 17; 18; 19; 20; 21; 22 mm
- 14pc 6pt. Flank deep socket (63mmL) 6; 7; 8; 9; 10; 11; 12; 13; 14; 15; 16; 17; 18; 19 mm
- 12pc Star socket E4; E5; E6; E7; E8; E10; E11; E12; E14; E16; E18; E20
- 1pc Quick-release pear ratchet handle 72teeth (80238)
- 2pc Extension 3"(75mm); 6"(150mm)
- 1pc Universal joint
- 1pc Adaptor for extension 1/2"(F)x3/8"(M)

- 1/2"DR. Part
- 21pc 6pt. Flank socket 10; 11; 12; 13; 14; 15; 16; 17; 18; 19; 20; 21; 22; 23; 24; 25; 26; 27; 28; 30; 32 mm
- 2pc Spark plug socket 16; 20.6 mm
- 2pc Hex socket bit (55mmL) 10; 12 mm
- 1pc Hex socket bit (65mmL) 14mm
- 1pc Hex socket bit (70mmL) 17mm
- 4pc Star socket bit (55mmL) T45; T50; T55; T60
- 7pc Spline socket bit (55mmL) M5; M6; M8; M9; M10; M12; M14
- 1pc Spline security socket bit (55mmL) M16
- 1pc Quick-release pear ratchet handle 72teeth (80248)
- 2pc Extension 5"(125mm); 10"(250mm)
- 1pc Universal joint
- 1pc Adaptor for extension 3/8"(F)x1/2"(M)



NO.2415

41pc Screwdriver & L key set

- 2pc Phillips stubby screwdriver PH.1; PH.2 (25mmL)
- 4pc Phillips screwdriver PH.0 (60mmL); PH.1 (80mmL); PH.2 (100mmL); PH.3 (150mmL)
- 2pc Slotted stubby screwdriver 5.5; 6.5 mm (25mmL)
- 6pc Slotted screwdriver 3mm (75mmL); 3.5mm (100mmL); 4mm (100mmL); 5.5mm (125mmL); 6.5mm (150mmL); 8mm (175mmL)
- 7pc Star screwdriver T10 (80mmL); T15 (80mmL); T20 (100mmL); T25 (100mmL); T27 (115mmL); T30 (115mmL); T40 (130mmL)
- 11pc Long hex key (5116L) 1.5; 2; 2.5; 3; 4; 5; 6; 7; 8; 10; 12 mm
- 9pc Long star key (5098L) T10; T15; T20; T25; T27; T30; T40; T45; T50



NO.41301

130pc 1/4" & 1/2" Socket combination set

- 1/4"DR. Part
- 12pc 6pt. Flank socket 4; 4.5; 5; 5.5; 6; 7; 8; 9; 10; 11; 12; 13 mm
- 12pc 6pt. Flank deep socket (50mmL) 4; 4.5; 5; 5.5; 6; 7; 8; 9; 10; 11; 12; 13 mm
- 6pc Star socket E4; E5; E6; E7; E8; E10
- 35pc Socket bit (32mmL)
 - Phillips PH.0; PH.1; PH.2; PH.3
 - Pozidriv PZ.0; PZ.1; PZ.2; PZ.3
 - Slotted 4; 5.5; 6.5; 7 mm
 - Hex 3; 4; 5; 6; 7; 8; 10 mm
 - Star T8; T10; T15; T20; T25; T27; T30; T40
 - Star tamperproof T-8H; T-10H; T-15H; T-20H; T-25H; T-27H; T-30H; T-40H
- 1pc Quick-release pear ratchet handle 72teeth (80228)
- 3pc Extension 2"(50mm); 4"(100mm); 6"(150mm)
- 1pc Universal joint
- 1pc Adaptor for extension 3/8"(F)x1/4"(M)
- 1pc Magnetic socket pick-up (25mmL)
- 1pc Spinner 6"(150mm) with 1/4"DR.(F)

- 1/2"DR. Part
- 21pc 6pt. Flank socket 10; 11; 12; 13; 14; 15; 16; 17; 18; 19; 20; 21; 22; 23; 24; 25; 26; 27; 28; 30; 32 mm
- 14pc 6pt. Flank deep socket (77mmL) 14; 15; 16; 17; 18; 19; 20; 21; 22; 23; 24; 27; 30; 32 mm
- 8pc Star socket E11; E12; E14; E16; E18; E20; E22; E24
- 2pc Spark plug socket 16; 20.6 mm
- 2pc Hex socket bit (55mmL) 10; 12 mm
- 1pc Hex socket bit (65mmL) 14mm
- 4pc Star socket bit (55mmL) T40; T45; T50; T55
- 1pc Quick-release pear ratchet handle 72teeth (80248)
- 2pc Extension 5"(125mm); 10"(250mm)
- 1pc Universal joint
- 1pc Adaptor for extension 3/8"(F)x1/2"(M)

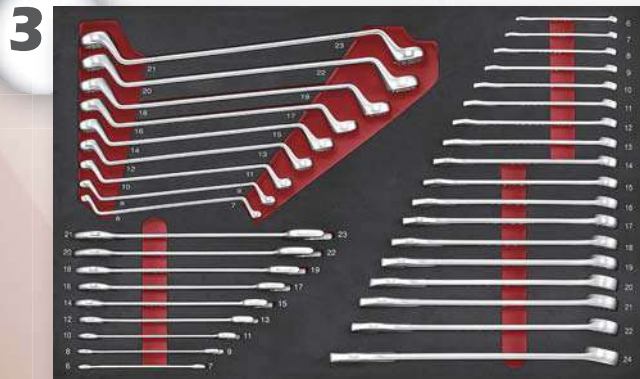

NO.5363

36pc Automotive essential wrench set

- 9pc Double open end wrench 6x7; 8x9; 10x11; 12x13; 14x15; 16x17; 18x19; 20x22; 21x23 mm
- 18pc Combination wrench 6; 7; 8; 9; 10; 11; 12; 13; 14; 15; 16; 17; 18; 19; 20; 21; 22; 24 mm
- 9pc 75° Offset ring wrench 6x7; 8x9; 10x11; 12x13; 14x15; 16x17; 18x19; 20x22; 21x23 mm

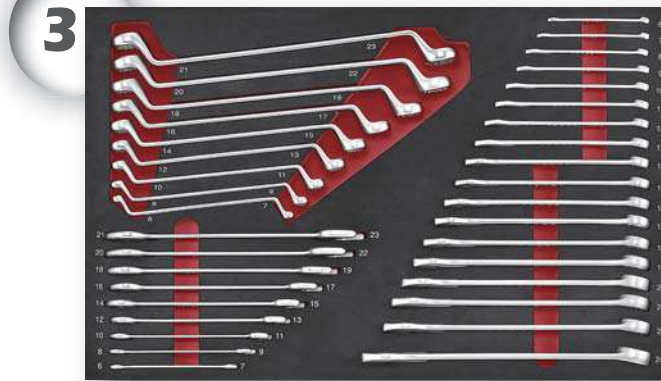

NO.5363

36pc Automotive essential wrench set

- 9pc Double open end wrench 6x7; 8x9; 10x11; 12x13; 14x15; 16x17; 18x19; 20x22; 21x23 mm
- 18pc Combination wrench 6; 7; 8; 9; 10; 11; 12; 13; 14; 15; 16; 17; 18; 19; 20; 21; 22; 24 mm
- 9pc 75° Offset ring wrench 6x7; 8x9; 10x11; 12x13; 14x15; 16x17; 18x19; 20x22; 21x23 mm



NO.5225

22pc Pliers and hammer chisel set

- 3pc Chisel 12 (150mmL); 19 (200mmL); 25 (220mmL)
- 1pc Cape chisel (150mmL)
- 7pc Pin punch 2 (140mmL); 3 (150mmL); 4 (190mmL); 5 (200mmL); 6 (210mmL); 8 (215mmL); 10 (230mmL)
- 1pc Center punch 4 (185mmL)
- 1pc Long nose pliers 8"(200mm)
- 1pc Bent long nose pliers 8"(200mm)
- 1pc Combination pliers 7"(175mm)
- 1pc Diagonal pliers 7"(175mm)
- 1pc Waterpump pliers 10"(250mm)
- 1pc Locking pliers 10"(250mm)
- 1pc Engineer hammer 300gw
- 1pc Rubber hammer 520gw
- 1pc Adjustable gauged wrench 10"(250mm)
- 1pc Electrician folding knife

10517-199

10517B-199

10517-229

10517B-229



NO.2407
40pc Screwdriver and (De)Magnetizer set

- 12pc 1/4" Double-sized bit (165mmL)
 - ⊕ Phillips PH.1xPH.2; PH.3xPH.4
 - ⊕ Pozidriv PZ.1xPZ.2; PZ.3xPZ.4
 - ⊖ Slotted 3x4; 5.5x7 mm
 - ⊖ Hex 3x4; 5x6 mm
 - ⊕ Star T8xT10; T15xT20; T25xT27; T30xT40
- 7pc 1/4" Five-sided star tamperproof socket bit (32mmL)
 - TS10; TS15; TS20; TS25; TS27; TS30; TS40
- 1pc 1/4" Adaptor 1/4"inhex-1/4"(M)
- 1pc 1/4" Bit driver handle 1/4"inhex 5"(125mm)
- 2pc ⊕ Phillips stubby screwdriver PH.1; PH.2 (25mmL)
- 2pc ⊕ Adjustment phillips screwdriver PH.1; PH.2 (350mmL)
- 2pc ⊖ Slotted stubby screwdriver 5.5; 6.5 mm (25mmL)
- 4pc ⊖ Adjustment slotted screwdriver 4; 5; 6; 8 mm (300mmL)
- 1pc ⊖ Hammer slotted screwdriver 8mm (150mmL)
- 7pc ⊕ Extra-long star screwdriver
 - T10; T15; T20; T25; T27; T30; T40 (300mmL)
- 1pc Demagnetizer / Magnetizer



NO.31561
156pc 1/4" & 3/8" Socket combination set

- 1/4"DR. Part
 - 12pc ⊖ 6pt. Flank socket
 - 4; 4.5; 5; 5.5; 6; 7; 8; 9; 10; 11; 12; 13 mm
 - 12pc ⊖ 6pt. Flank deep socket (50mmL)
 - 4; 4.5; 5; 5.5; 6; 7; 8; 9; 10; 11; 12; 13 mm
 - 8pc ⊖ Star socket
 - E4; E5; E6; E7; E8; E10; E11; E12
 - 37pc Socket bit (32mmL)
 - ⊕ Phillips PH.0; PH.1; PH.2; PH.3
 - ⊕ Pozidriv PZ.0; PZ.1; PZ.2; PZ.3
 - ⊖ Slotted 4; 5.5; 6.5; 7 mm
 - ⊖ Hex 3; 4; 5; 6; 7; 8; 10 mm
 - ⊕ Star T8; T10; T15; T20; T25; T27; T30; T35; T40
 - ⊕ Star tamperproof
 - T-8H; T-10H; T-15H; T-20H; T-25H; T-27H; T-30H; T-35H; T-40H
 - 1pc Flexible round ratchet handle 72teeth (802223)
 - 1pc Quick-release curved-shank ratchet handle 36teeth (802227)
 - 3pc Extension 2"(50mm); 4"(100mm); 6"(150mm)
 - 1pc Universal joint
 - 1pc Adaptor for extension 3/8"(F)x1/4"(M)
 - 1pc Adaptor 3/8"(F)x1/4"(M)
 - 1pc Flexible extension 5.8"(145mm)
 - 1pc Magnetic socket pick-up (25mmL)
 - 1pc Spinner 6"(150mm) with 1/4"DR.(F)

- 3/8"DR. Part
 - 15pc ⊖ 6pt. Flank socket
 - 8; 9; 10; 11; 12; 13; 14; 15; 16; 17; 18; 19; 20; 21; 22 mm
 - 12pc ⊖ 6pt. Flank deep socket (63mmL)
 - 8; 9; 10; 11; 12; 13; 14; 15; 16; 17; 18; 19 mm
 - 7pc ⊖ Star socket E8; E10; E11; E12; E14; E16; E18
 - 7pc ⊖ Star deep socket (63mmL) E8; E10; E11; E12; E14; E16; E18
 - 2pc ⊖ Magnetic spark plug socket (thin-wall) 14; 16 mm
 - 2pc ⊖ Magnetic long spark plug socket (250mmL) 14; 16 mm
 - 1pc Quick-release pear ratchet handle 72teeth (80238)
 - 1pc Quick-release flexible pear ratchet handle 30teeth (802318)
 - 1pc Quakeproof impact driver (8173)
 - 2pc Extension 3"(75mm); 6"(150mm)
 - 1pc Universal joint
 - 1pc Adaptor for extension 1/2"(F)x3/8"(M)
 - 2pc Bit holder 3/8"DR.x1/4"(F); 3/8"DR.x5/16"(F)

- Bits
 - 22pc 5/16" Bit
 - ⊕ Phillips (36mmL) PH.1; PH.2; PH.3
 - ⊕ Phillips (38mmL) PH.4
 - ⊕ Pozidriv (36mmL) PZ.2; PZ.3
 - ⊕ Pozidriv (38mmL) PZ.4
 - ⊖ Slotted (36mmL) 9; 10; 11; 12 mm
 - ⊖ Hex (36mmL) 6; 8; 10 mm
 - ⊕ Star (35mmL) T20; T25; T27; T30; T40; T45; T50; T55



NO.41051
105pc 1/2"DR. Socket combination set

- 1/2"DR. Part
 - 21pc ⊖ 6pt. Flank socket
 - 10; 11; 12; 13; 14; 15; 16; 17; 18; 19; 20; 21; 22; 23; 24; 25; 26; 27; 28; 30; 32 mm
 - 10pc ⊖ 6pt. Flank deep socket (77mmL)
 - 19; 20; 21; 22; 23; 24; 27; 28; 30; 32 mm
 - 10pc Star socket
 - E8; E10; E11; E12; E14; E16; E18; E20; E22; E24
 - 2pc ⊖ Spark plug socket 18; 20.6 mm
 - 1pc Quick-release pear ratchet handle 72teeth (80248)
 - 1pc Impact driver (8174)
 - 3pc Extension 3"(75mm); 5"(125mm); 10"(250mm)
 - 1pc Universal joint
 - 1pc Adaptor for extension 3/8"(F)x1/2"(M)
 - 1pc Bit holder 1/2"DR.x10mm(F)

- Bits
 - 8pc ⊖ 10mm Hex bit (30mmL) 4; 5; 6; 7; 8; 9; 10; 12 mm
 - 8pc ⊖ 10mm Hex bit (75mmL) 4; 5; 6; 7; 8; 9; 10; 12 mm
 - 11pc ⊕ 10mm Star bit (30mmL)
 - T20; T25; T27; T30; T35; T40; T45; T47; T50; T55; T60
 - 11pc ⊕ 10mm Star bit (75mmL)
 - T20; T25; T27; T30; T35; T40; T45; T47; T50; T55; T60
 - 8pc ⊖ 10mm Spline bit (30mmL) M5; M6; M7; M8; M9; M10; M12; M14
 - 8pc ⊖ 10mm Spline bit (75mmL) M5; M6; M7; M8; M9; M10; M12; M14



NO.5225
22pc Pliers and hammer chisel set

- 3pc Chisel 12 (150mmL); 19 (200mmL); 25 (220mmL)
- 1pc Cape chisel (150mmL)
- 7pc Pin punch
 - 2 (140mmL); 3 (150mmL); 4 (190mmL); 5 (200mmL); 6 (210mmL); 8 (215mmL); 10 (230mmL)
- 1pc Center punch 4 (185mmL)
- 1pc Long nose pliers 8"(200mm)
- 1pc Bent long nose pliers 8"(200mm)
- 1pc Combination pliers 7"(175mm)
- 1pc Diagonal pliers 7"(175mm)
- 1pc Waterpump pliers 10"(250mm)
- 1pc Locking pliers 10"(250mm)
- 1pc Engineer hammer 300gw
- 1pc Rubber hammer 520gw
- 1pc Adjustable gauged wrench 10"(250mm)
- 1pc Electrician folding knife



NO.5361
36pc Spanner set

- 23pc Combination wrench
 - 6; 7; 8; 9; 10; 11; 12; 13; 14; 15; 16; 17; 18; 19; 21; 22; 23; 24; 26; 27; 28; 30; 32 mm
- 13pc 75° Offset ring wrench
 - 6x7; 8x9; 10x11; 12x13; 14x15; 16x17; 18x19; 21x23; 20x22; 23x26; 24x27; 25x28; 30x32 mm



NO.5273
27pc Hex grip key, hex socket driver and auto body tool set

- 7pc ⊖ Hex socket driver (250mmL)
 - 6; 7; 8; 10; 11; 12; 13 mm
- 7pc ⊖ Hex & Hex ball point grip key
 - 2; 2.5; 3; 4; 5; 6; 8 mm
- 1pc Pointer-pointed side trim removal tool
- 1pc Spreader trim removal tool
- 1pc Viper's tongue - lever side trim removal tool
- 1pc Ski side trim removal tool
- 1pc Full hook
- 1pc 90° hook
- 1pc Angle hook
- 1pc Straight pick
- 1pc Trim pad remover (big)
- 1pc Trim pad remover (small)
- 1pc Gasket scraper
- 1pc Radiator hose remover
- 1pc Cotter pin puller

10517-386

10517B-386





NO.2412

41pc Screwdriver and L key set

- 2pc Phillips stubby screwdriver PH.1; PH.2 (25mmL)
- 4pc Phillips screwdriver PH.0 (60mmL); PH.1 (80mmL); PH.2 (100mmL); PH.3 (150mmL)
- 2pc Slotted stubby screwdriver 5.5; 6.5 mm (25mmL)
- 5pc Slotted screwdriver 3mm (75mmL); 4mm (100mmL); 5.5mm (125mmL); 6.5mm (150mmL); 8mm (175mmL)
- 7pc Star screwdriver T10 (80mmL); T15 (80mmL); T20 (100mmL); T25 (100mmL); T27 (115mmL); T30 (115mmL); T40 (130mmL)
- 11pc Hex key (5116) 1.5; 2; 2.5; 3; 4; 5; 6; 7; 8; 10; 12 mm
- 9pc Star key (5098) T10; T15; T20; T25; T27; T30; T40; T45; T50
- 1pc Demagnetizer / Magnetizer



NO.4882

88pc 1/4" & 3/8" & 1/2" Socket combination set

- 1/4"DR. Part
- 13pc 6pt. Flank socket 3.2; 4; 4.5; 5; 5.5; 6; 7; 8; 9; 10; 11; 12; 13 mm
- 4pc 6pt. Flank deep socket (50mmL) 6; 7; 8; 10 mm
- 1pc Quick-release pear ratchet handle 20teeth (802215)
- 3pc Extension 2"(50mm); 4"(100mm); 6"(150mm)
- 1pc Universal joint
- 1pc Adaptor for extension 3/8"(F)x1/4"(M)
- 1pc Magnetic socket pick-up (25mmL)
- 1pc Spinner 6"(150mm) with 1/4"DR.(F)
- 3/8"DR. Part
- 12pc 6pt. Flank socket 8; 9; 10; 11; 12; 13; 14; 15; 16; 17; 18; 19 mm
- 6pc 6pt. Flank deep socket (63mmL) 8; 9; 10; 12; 13; 14 mm
- 4pc Magnetic spark plug socket 14; 16; 18; 20.6 mm
- 1pc Quick-release pear ratchet handle 30teeth (802315)
- 2pc Extension 3"(75mm); 6"(150mm)
- 1pc Universal joint
- 1pc Adaptor for extension 1/2"(F)x3/8"(M)
- 1/2"DR. Part
- 20pc 6pt. Flank socket 10; 11; 12; 13; 14; 15; 16; 17; 18; 19; 20; 21; 22; 23; 24; 26; 27; 28; 30; 32 mm
- 11pc 6pt. Flank deep socket (77mmL) 13; 14; 15; 17; 19; 21; 22; 24; 27; 30; 32 mm
- 1pc Quick-release pear ratchet handle 36teeth (802415)
- 2pc Extension 5"(125mm); 10"(250mm)
- 1pc Universal joint
- 1pc Adaptor for extension 3/8"(F)x1/2"(M)

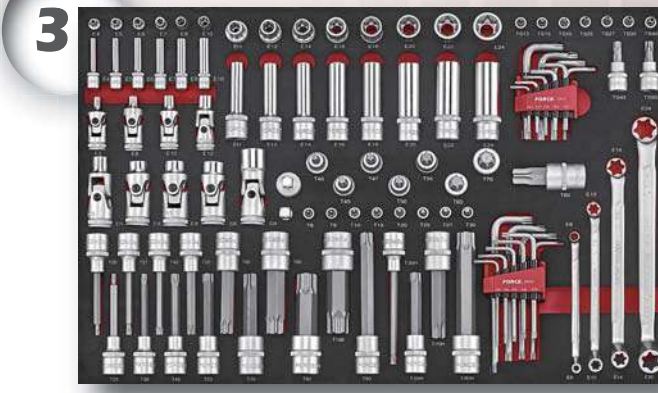

NO.41041

104pc 1/4" & 3/8" & 1/2" Star & Five-sided star set

- 1/4"DR. Part
- 6pc Star socket E4; E5; E6; E7; E8; E10
- 6pc Star deep socket (50mmL) E4; E5; E6; E7; E8; E10
- 8pc Star socket bit (32mmL) T8; T9; T10; T15; T20; T25; T27; T30
- 7pc Five-sided star tamperproof socket bit (32mmL) TS10; TS15; TS20; TS25; TS27; TS30; TS40
- 1pc Adaptor 1/4"(F)x3/8"(M)
- 3/8"DR. Part
- 4pc Universal star socket (42mmL) E6; E8; E10; E12
- 2pc Five-sided star tamperproof socket bit (50mmL) TS45; TS50
- 1/2"DR. Part
- 8pc Star socket E11; E12; E14; E16; E18; E20; E22; E24
- 8pc Star deep socket (77mmL) E11; E12; E14; E16; E18; E20; E22; E24
- 5pc Universal star socket (65mmL) E14; E16; E18; E20; E24
- 7pc Star socket bit (55mmL) T40; T45; T47; T50; T55; T60; T70
- 1pc Star socket bit (70mmL) T80
- 13pc Star socket bit (100mmL) T20; T25; T27; T30; T40; T45; T50; T55; T60; T70; T80; T90; T100
- 1pc Star socket bit (140mmL) T60
- 1pc Star tamperproof socket bit (100mmL) T-55H
- 1pc Star tamperproof socket bit (105mmL) T-70H
- 1pc Star tamperproof socket bit (130mmL) T-30H
- 1pc Star tamperproof socket bit (140mmL) T-80H
- 1pc Adaptor 1/2"(F)x3/8"(M)
- Others
- 4pc 75° Offset star wrench E6xE8; E10xE12; E14xE18; E20xE24
- 9pc Long star tamperproof key (5098LT) T-10H; T-15H; T-20H; T-25H; T-27H; T-30H; T-40H; T-45H; T-50H
- 9pc Five-sided star tamperproof key (50913) TS10; TS15; TS20; TS25; TS27; TS30; TS40; TS45; TS50



NO.5207

20pc Pliers & chisel set

- 3pc Chisel 12 (150mmL); 15 (180mmL); 19 (200mmL)
- 1pc Ribbed flat chisel 26 (200mmL)
- 4pc Pin punch 4 (190mmL); 5 (200mmL); 6 (210mmL); 8 (215mmL)
- 3pc Center punch 2.5 (185mmL); 4 (185mmL); 6 (185mmL)
- 1pc Long nose pliers 8"(200mm)
- 1pc Bent long nose pliers 8"(200mm)
- 1pc Combination pliers 7"(175mm)
- 1pc Diagonal pliers 7"(175mm)
- 1pc Waterpump pliers 10"(250mm)
- 1pc Locking pliers 10"(250mm)
- 1pc Engineer hammer 300gw
- 1pc Rubber hammer 400gw
- 1pc Adjustable gauged wrench 10"(250mm)



NO.2195

19pc Hex-ball grip key and Hex nut T handle set

- 10pc Hex & hex ball point grip key 2; 2.5; 3; 4; 5; 6; 7; 8; 10; 12 mm
- 9pc T-handle hex socket driver 5; 6; 7; 8; 9; 10; 11; 12; 13 mm (300mmL)

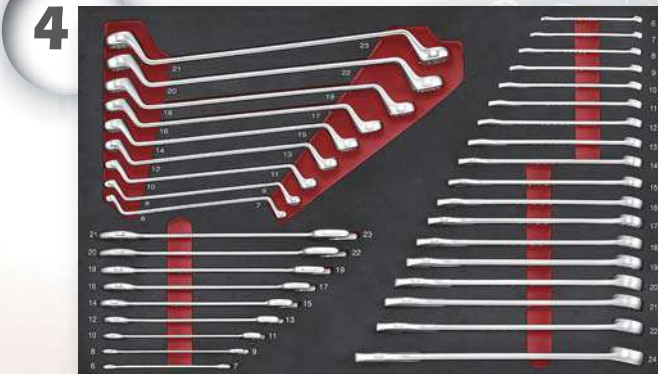

NO.5363

36pc Automotive essential wrench set

- 9pc Double open end wrench 6x7; 8x9; 10x11; 12x13; 14x15; 16x17; 18x19; 20x22; 21x23 mm
- 18pc Combination wrench 6; 7; 8; 9; 10; 11; 12; 13; 14; 15; 16; 17; 18; 19; 20; 21; 22; 24 mm
- 9pc 75° Offset ring wrench 6x7; 8x9; 10x11; 12x13; 14x15; 16x17; 18x19; 20x22; 21x23 mm

- 10217-308
- 10218-308
- 10217B-308
- 10218B-308
- 10217R-308
- 10218R-308
- 10217A-308
- 10218A-308





NO.2415
41pc Screwdriver & L key set

- 2pc Phillips stubby screwdriver PH.1; PH.2 (25mmL)
- 4pc Phillips screwdriver PH.0 (60mmL); PH.1 (80mmL); PH.2 (100mmL); PH.3 (150mmL)
- 2pc Slotted stubby screwdriver 5.5; 6.5 mm (25mmL)
- 6pc Slotted screwdriver 3mm (75mmL); 3.5mm (100mmL); 4mm (100mmL); 5.5mm (125mmL); 6.5mm (150mmL); 8mm (175mmL)
- 7pc Star screwdriver T10 (80mmL); T15 (80mmL); T20 (100mmL); T25 (100mmL); T27 (115mmL); T30 (115mmL); T40 (130mmL)
- 11pc Long hex key (5116L) 1.5; 2; 2.5; 3; 4; 5; 6; 7; 8; 10; 12 mm
- 9pc Long star key (5098L) T10; T15; T20; T25; T27; T30; T40; T45; T50



NO.4685
68pc 1/2"DR. Socket & socket bit set

- 17pc 6pt. Flank deep socket (77mmL) 8; 10; 11; 12; 13; 14; 15; 16; 17; 18; 19; 21; 22; 24; 27; 30; 32 mm
- 8pc Hex socket bit (55mmL) 4; 5; 6; 7; 8; 10; 11; 12 mm
- 1pc Hex socket bit (65mmL) 14mm
- 2pc Hex socket bit (70mmL) 17; 19 mm
- 8pc Hex socket bit (100mmL) 4; 5; 6; 7; 8; 10; 12; 14 mm
- 9pc Star socket bit (55mmL) T20; T25; T27; T30; T40; T45; T50; T55; T60
- 9pc Star socket bit (100mmL) T20; T25; T27; T30; T40; T45; T50; T55; T60
- 6pc Spline socket bit (55mmL) M8; M9; M10; M12; M14; M16
- 6pc Spline socket bit (100mmL) M8; M9; M10; M12; M14; M16
- 1pc Spline security socket bit (55mmL) M16
- 1pc Spline security socket bit (100mmL) M16



NO.41281
128pc 1/4" & 3/8" & 1/2" Socket combination set

- 1/4"DR. Part
 - 14pc 6pt. Flank socket 3.2; 4; 4.5; 5; 5.5; 6; 7; 8; 9; 10; 11; 12; 13; 14 mm
 - 11pc 6pt. Flank deep socket (50mmL) 4; 5; 6; 7; 8; 9; 10; 11; 12; 13; 14 mm
 - 6pc Star socket E4; E5; E6; E7; E8; E10
 - 34pc Socket bit (32mmL)
 - Phillips PH.0; PH.1; PH.2; PH.3
 - Pozidriv PZ.0; PZ.1; PZ.2; PZ.3
 - Slotted 4; 5.5; 6.5 mm
 - Hex 3; 4; 5; 6; 7; 8; 10 mm
 - Star T8; T10; T15; T20; T25; T27; T30; T40
 - Star tamperproof T-8H; T-10H; T-15H; T-20H; T-25H; T-27H; T-30H; T-40H
 - 1pc Quick-release pear ratchet handle 20teeth (802215)
 - 3pc Extension 2"(50mm); 4"(100mm); 6"(150mm)
 - 1pc Universal joint
 - 1pc Adaptor for extension 3/8"(F)x1/4"(M)
 - 1pc Magnetic socket pick-up (25mmL)
 - 1pc Spinner 6"(150mm) with 1/4"DR.(F)
- 3/8"DR. Part
 - 12pc 6pt. Flank socket 8; 9; 10; 11; 12; 13; 14; 15; 16; 17; 18; 19 mm
 - 4pc Magnetic spark plug socket 14; 16; 18; 20.6 mm
 - 1pc Quick-release pear ratchet handle 30teeth (802315)
 - 2pc Extension 3"(75mm); 6"(150mm)
 - 1pc Universal joint
 - 1pc Adaptor for extension 1/2"(F)x3/8"(M)
- 1/2"DR. Part
 - 20pc 6pt. Flank socket 10; 11; 12; 13; 14; 15; 16; 17; 18; 19; 20; 21; 22; 23; 24; 26; 27; 28; 30; 32 mm
 - 8pc Star socket E11; E12; E14; E16; E18; E20; E22; E24
 - 1pc Quick-release pear ratchet handle 36teeth (802415)
 - 1pc Swivel handle 15"(380mm)
 - 2pc Extension 5"(125mm); 10"(250mm)
 - 1pc Sliding T handle 10"(250mm)
 - 1pc Universal joint

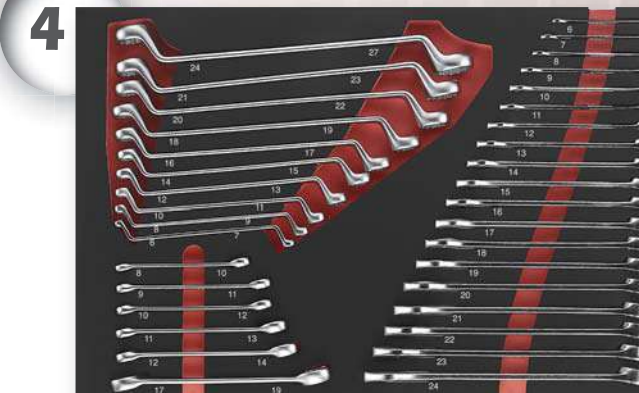

NO.5353
35pc Wrench set

- 6pc Flare nut wrench 8x10; 9x11; 10x12; 11x13; 12x14; 17x19 mm
- 19pc Combination wrench 6; 7; 8; 9; 10; 11; 12; 13; 14; 15; 16; 17; 18; 19; 20; 21; 22; 23; 24 mm
- 10pc 75° Offset ring wrench 6x7; 8x9; 10x11; 12x13; 14x15; 16x17; 18x19; 20x22; 21x23; 24x27 mm



NO.5207
20pc Pliers & chisel set

- 3pc Chisel 12 (150mmL); 15 (180mmL); 19 (200mmL)
- 1pc Ribbed flat chisel 26 (200mmL)
- 4pc Pin punch 4 (190mmL); 5 (200mmL); 6 (210mmL); 8 (215mmL)
- 3pc Center punch 2.5 (185mmL); 4 (185mmL); 6 (185mmL)
- 1pc Long nose pliers 8"(200mm)
- 1pc Bent long nose pliers 8"(200mm)
- 1pc Combination pliers 7"(175mm)
- 1pc Diagonal pliers 7"(175mm)
- 1pc Waterpump pliers 10"(250mm)
- 1pc Locking pliers 10"(250mm)
- 1pc Engineer hammer 300gw
- 1pc Rubber hammer 400gw
- 1pc Adjustable gauged wrench 10"(250mm)



NO.5179
17pc Utility set

- 1pc Utility knife (include 3pc blades)
- 1pc Steel vernier caliper
- 1pc Auto center punch
- 1pc Stainless steel straight ruler 30cm
- 1pc Stainless steel protractor
- 1pc Screw pitch gauges 0.25-6 (Metric)
- 1pc Screw pitch gauges 4-62 (SAE)
- 1pc Steel scriber
- 1pc 5m measuring tape
- 1pc Snap ring pliers internal 90° bent 7"(180mm)
- 1pc Snap ring pliers internal straight 7"(180mm)
- 1pc Snap ring pliers external straight 7"(180mm)
- 1pc Feeler gauges of 26 sizes (SAE & Metric) (61802)
- 1pc Hacksaw 13"(330mm)
- 1pc Aviation tin snips-straight cut 10"(250mm)
- 1pc Wire brush



NO.4615
61pc 1/2"DR. Impact socket and socket bit set

- 16pc 6pt. Flank impact socket 10; 12; 13; 14; 15; 16; 17; 18; 19; 21; 22; 24; 27; 30; 32; 36 mm
- 16pc 6pt. Flank deep impact socket (85mmL) 10; 12; 13; 14; 15; 16; 17; 18; 19; 21; 22; 24; 27; 30; 32; 36 mm
- 3pc Thin-wall 6pt. flank deep impact socket (85mmL) 17; 19; 21 mm
- 3pc Colored 6pt. flank deep impact socket (85mmL) 17; 19; 21 mm
- 8pc Hex impact socket bit (one-piece) (60mmL) 5; 6; 8; 10; 12; 14; 17; 19 mm
- 7pc Star impact socket bit (one-piece) (60mmL) T30; T40; T45; T50; T55; T60; T70
- 3pc Spline impact socket bit (one-piece) (60mmL) M8; M10; M12
- 2pc Impact extension (ball type) 5"(125mm); 10"(250mm)
- 1pc Impact universal joint (ball type)
- 2pc Impact adaptor (ball type) 3/8"(F)x1/2"(M); 3/4"(F)x1/2"(M)

■ 10218-370 ■ 10218R-370

■ 10218B-370 ■ 10218A-370



NO.2262

26pc Screwdriver set

- 2pc Phillips stubby screwdriver PH.1; PH.2 (25mmL)
- 3pc Phillips screwdriver PH.1 (80mmL); PH.2 (100mmL); PH.3 (150mmL)
- 2pc Slotted stubby screwdriver 5.5; 6.5 mm (25mmL)
- 6pc Slotted screwdriver 3mm (75mmL); 3.5mm (100mmL); 4mm (100mmL); 5.5mm (125mmL); 6.5mm (150mmL); 8mm (175mmL)
- 13pc Star screwdriver T5; T6; T7; T8; T9 (60mmL) T10; T15 (80mmL) T20; T25 (100mmL) T27; T30 (115mmL) T40; T45 (130mmL)



NO.21261

126pc 1/4"DR. Socket combination & L key set

- 1/4"DR. Part
- 12pc 6pt. Flank socket 4; 4.5; 5; 5.5; 6; 7; 8; 9; 10; 11; 12; 13 mm
- 6pc Star socket E4; E5; E6; E7; E8; E10
- 6pc Star deep socket (50mmL) E4; E5; E6; E7; E8; E10
- 9pc Universal 6pt. flank deep socket (65mmL) 5; 6; 7; 8; 9; 10; 11; 12; 13 mm
- 32pc Socket bit (32mmL) Phillips PH.0; PH.1; PH.2 Pozidriv PZ.0; PZ.1; PZ.2 Slotted 3; 4; 5.5; 6.5 mm Hex 3; 4; 5; 6; 7; 8 mm Star T8; T10; T15; T20; T25; T27; T30; T40 Star tamperproof T-8H; T-10H; T-15H; T-20H; T-25H; T-27H; T-30H; T-40H
- 1pc Lock torque wrench 6-30 Nm, 295mmL (6472295)
- 1pc Quick-release pear ratchet handle 20teeth (802215)
- 1pc Flexible round ratchet handle 72teeth (802223)
- 3pc Extension 2"(50mm); 4"(100mm); 6"(150mm)
- 1pc Universal joint
- 1pc Adaptor for extension 3/8"(F)x1/4"(M)
- 1pc Magnetic socket pick-up (25mmL)
- 1pc Spinner 6"(150mm) with 1/4"DR.(F)
- Others
- 2pc Phillips jeweler screwdriver PH.000; PH.00 (40mmL)
- 6pc Slotted jeweler screwdriver 1.0; 1.2; 1.5; 1.8; 2.0; 2.5 mm (40mmL)
- 4pc Star jeweler screwdriver T5; T6; T7; T8 (40mmL)
- 3pc Star tamperproof jeweler screwdriver T-5H; T-6H; T-7H (40mmL)
- 1pc Tweezers 5.5"(140mm)
- 10pc Long hex ball point key (5102LB) 1.27; 1.5; 2; 2.5; 3; 4; 5; 6; 8; 10 mm
- 9pc Long star & star ball point key (5098LB) T10; T15; T20; T25; T27; T30; T40; T45; T50
- 9pc Five-sided star tamperproof key (50913) TS10; TS15; TS20; TS25; TS27; TS30; TS40; TS45; TS50
- 7pc Spline key M5; M6; M8; M10; M12; M14; M16

- 10218-405 ■ 10218R-405
- 10218B-405 ■ 10218A-405



NO.3981

98pc 3/8"DR. Socket combination set

- 16pc 6pt. Flank socket 6; 7; 8; 9; 10; 11; 12; 13; 14; 15; 16; 17; 18; 19; 21; 22 mm
- 8pc Star socket E6; E7; E8; E10; E11; E12; E14; E16
- 2pc Star deep socket (55mmL) E6; E7
- 6pc Star deep socket (63mmL) E8; E10; E11; E12; E14; E16
- 10pc Universal 6pt. flank deep socket (85mmL) 10; 11; 12; 13; 14; 15; 16; 17; 18; 19 mm
- 3pc Spark plug socket 16; 18; 20.6 mm
- 2pc Magnetic long spark plug socket (250mmL) 14; 16 mm
- 10pc Hex socket bit (50mmL) 3; 4; 5; 5.5; 6; 7; 8; 9; 10; 12 mm
- 12pc Star socket bit (50mmL) T8; T10; T15; T20; T25; T27; T30; T40; T45; T50; T55; T60
- 12pc Star tamperproof socket bit (50mmL) T-8H; T-10H; T-15H; T-20H; T-25H; T-27H; T-30H; T-40H; T-45H; T-50H; T-55H; T-60H
- 6pc Spline socket bit (50mmL) M5; M6; M8; M9; M10; M12
- 1pc Universal star socket bit (65mmL) T45
- 1pc Lock torque wrench 20-110 Nm, 380mmL (6473380)
- 1pc Quick-release pear ratchet handle 30teeth (802315)
- 1pc Flexible round ratchet handle 72teeth (802323)
- 3pc Extension 3"(75mm); 6"(150mm); 9"(225mm)
- 1pc Universal joint
- 1pc Adaptor for extension 3/8"(F)x3/8"(M)
- 2pc Torque adaptor 18Nm; 24Nm



NO.4662

66pc 1/2"DR. Socket combination set

- 21pc 6pt. Flank socket 8; 10; 11; 12; 13; 14; 15; 16; 17; 18; 19; 20; 21; 22; 23; 24; 26; 27; 28; 30; 32 mm
- 8pc Star socket E8; E10; E12; E14; E16; E18; E20; E24
- 8pc Star deep socket (77mmL) E8; E10; E12; E14; E16; E18; E20; E24
- 8pc Universal 6pt. flank deep socket (108mmL) 13; 14; 15; 17; 19; 21; 22; 24 mm
- 14pc Socket bit (55mmL) Star T45; T50; T55; T60; T70 Star tamperproof T-45H; T-50H; T-55H; T-60H; T-70H Spline M10; M12; M14; M16
- 1pc Lock torque wrench 40-210 Nm, 535mmL (6474535)
- 1pc Quick-release pear ratchet handle 36teeth (802415)
- 1pc Swivel handle 15"(380mm)
- 2pc Extension 5"(125mm); 10"(250mm)
- 1pc Universal joint
- 1pc Adaptor for extension 3/8"(F)x1/2"(M)

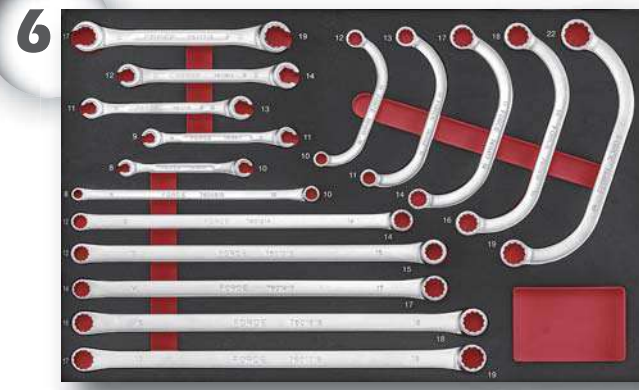

NO.5168

16pc Automotive special wrench set

- 5pc Flare nut wrench 8x10; 9x11; 11x13; 12x14; 17x19 mm
- 6pc Extra-long flat ring wrench 8x10; 12x14; 13x15; 14x17; 16x18; 17x19 mm
- 5pc Half-moon ring wrench 10x12; 11x13; 14x17; 16x18; 19x22 mm

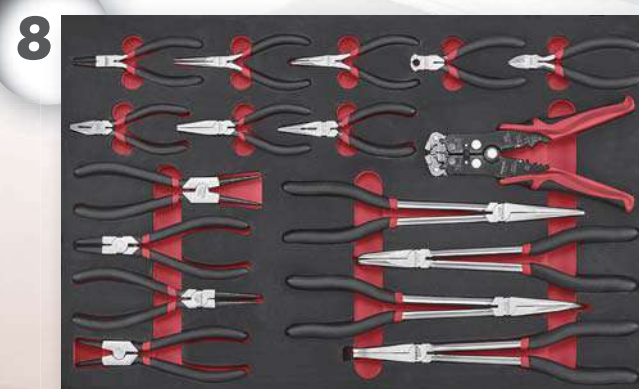

NO.5363

36pc Automotive essential wrench set

- 9pc Double open end wrench 6x7; 8x9; 10x11; 12x13; 14x15; 16x17; 18x19; 20x22; 21x23 mm
- 18pc Combination wrench 6; 7; 8; 9; 10; 11; 12; 13; 14; 15; 16; 17; 18; 19; 20; 21; 22; 24 mm
- 9pc 75° Offset ring wrench 6x7; 8x9; 10x11; 12x13; 14x15; 16x17; 18x19; 20x22; 21x23 mm



NO.5207

20pc Pliers & chisel set

- 3pc Chisel 12 (150mmL); 15 (180mmL); 19 (200mmL)
- 1pc Ribbed flat chisel 26 (200mmL)
- 4pc Pin punch 4 (190mmL); 5 (200mmL); 6 (210mmL); 8 (215mmL)
- 3pc Center punch 2.5 (185mmL); 4 (185mmL); 6 (185mmL)
- 1pc Long nose pliers 8"(200mm)
- 1pc Bent long nose pliers 8"(200mm)
- 1pc Combination pliers 7"(175mm)
- 1pc Diagonal pliers 7"(175mm)
- 1pc Waterpump pliers 10"(250mm)
- 1pc Locking pliers 10"(250mm)
- 1pc Engineer hammer 300gw
- 1pc Rubber hammer 400gw
- 1pc Adjustable gauged wrench 10"(250mm)

NO.5178

17pc Pliers set

- 1pc Long nose straight long pliers 11"(280mm)
- 1pc Long nose 45° long pliers 11"(280mm)
- 1pc Long nose 90° long pliers 11"(280mm)
- 1pc Multi-purpose 4 points gripping pliers 11"(280mm)
- 1pc Round nose pliers 5"(125mm)
- 1pc Flat nose pliers 5"(125mm)
- 1pc Combination pliers 5"(125mm)
- 1pc Long nose pliers 5"(125mm)
- 1pc Needle nose pliers 6"(150mm)
- 1pc Bent nose pliers 6"(150mm)
- 1pc Cutter pliers 6"(150mm)
- 1pc Diagonal pliers 6"(150mm)
- 1pc Snap ring pliers internal 90° bent 7"(180mm)
- 1pc Snap ring pliers external 90° bent 7"(180mm)
- 1pc Snap ring pliers internal straight 7"(180mm)
- 1pc Snap ring pliers external straight 7"(180mm)
- 1pc Multi-functional stripper pliers

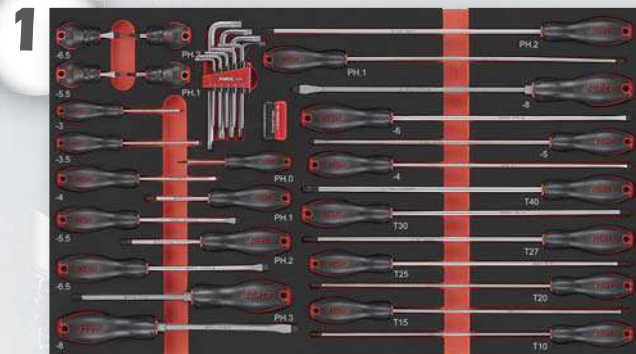

NO.2371

37pc Screwdriver set

- 2pc Phillips stubby screwdriver PH.1; PH.2 (25mm)
- 4pc Phillips screwdriver PH.0 (60mm); PH.1 (80mm); PH.2 (100mm); PH.3 (150mm)
- 2pc Adjustment phillips screwdriver PH.1; PH.2 (350mm)
- 2pc Slotted stubby screwdriver 5.5; 6.5 mm (25mm)
- 6pc Slotted screwdriver 3mm (75mm); 3.5mm (100mm); 4mm (100mm); 5.5mm (125mm); 6.5mm (150mm); 8mm (175mm)
- 4pc Adjustment slotted screwdriver 4; 5; 6; 8 mm (300mm)
- 7pc Extra-long star screwdriver T10; T15; T20; T25; T27; T30; T40 (300mm)
- 9pc Long star key (5098L) T10; T15; T20; T25; T27; T30; T40; T45; T50
- 1pc Demagnetizer / Magnetizer

- 3/8"DR. Part
- 19pc 6pt. Flank socket 6; 7; 8; 9; 10; 11; 12; 13; 14; 15; 16; 17; 18; 19; 20; 21; 22; 23; 24 mm
 - 6pc 6pt. Flank deep socket (63mm) 8; 9; 10; 12; 13; 14 mm
 - 4pc Spark plug socket 14; 16; 18; 20.6 mm
 - 6pc Spline socket bit (50mm) M5; M6; M8; M9; M10; M12
 - 1pc Quick-release pear ratchet handle 30teeth (802315)
 - 1pc Quick-release flexible pear ratchet handle 30teeth (802318)
 - 2pc Extension 3"(75mm); 6"(150mm)
 - 1pc Wobble extension 1.75"(44mm)
 - 1pc Universal joint
 - 1pc Adaptor for extension 1/2"(F)x3/8"(M)

- 1/2"DR. Part
- 16pc 6pt. Flank socket 10; 11; 12; 13; 14; 15; 16; 17; 18; 19; 21; 22; 24; 27; 30; 32 mm
 - 6pc 6pt. Flank deep socket (77mm) 14; 15; 17; 19; 22; 24 mm
 - 7pc Star socket E12; E14; E16; E18; E20; E22; E24
 - 1pc Quick-release pear ratchet handle 36teeth (802415)
 - 2pc Extension 5"(125mm); 10"(250mm)
 - 1pc Universal joint
 - 1pc Adaptor for extension 3/8"(F)x1/2"(M)

- Others:
- 10pc Long hex ball point key (5102LB) 1.27; 1.5; 2; 2.5; 3; 4; 5; 6; 8; 10 mm

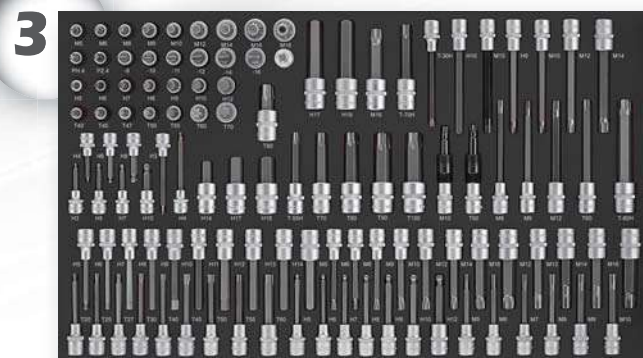

NO.41141

114pc 3/8" & 1/2" Socket bit set

- 3/8"DR. Part
- 9pc Hex ball point socket bit 3; 4; 5; 6; 7; 8; 10 mm (62mm)
 - 3; 4 mm (100mm)
- 1/2"DR. Part
- 1pc Phillips socket bit PH.4 (55mm)
 - 1pc Pozidriv socket bit PZ.4 (55mm)
 - 6pc Slotted socket bit 9; 10; 11; 12; 14; 16 mm (55mm)
 - 23pc Hex socket bit 5; 6; 7; 8; 9; 10; 12 mm (55mm); 14mm (65mm); 17; 19 mm (70mm); 5; 6; 7; 8; 9; 10; 11; 12; 13; 14 mm (100mm); 17; 19 mm (110mm); 10mm (140mm)
 - 7pc Hex ball point socket bit 5; 6; 7; 8; 9; 10; 12 mm (100mm)
 - 22pc Star socket bit T40; T45; T47; T50; T55; T60; T70 (55mm) T80 (70mm) T20; T25; T27; T30; T40; T45; T50; T55; T60; T70; T80; T90; T100 (100mm) T60 (140mm)
 - 4pc Star tamperproof socket bit T-55H (100mm); T-70H (105mm); T-30H (130mm); T-80H (140mm)
 - 20pc Spline socket bit M5; M6; M8; M9; M10; M12; M14; M16 (55mm) M5; M6; M8; M9; M10; M12; M14; M16 (100mm) M9; M10; M12; M14 (140mm)
 - 2pc Spline security socket bit M16 (55mm); M16 (100mm)
 - 13pc Ribe socket bit M5; M6; M7; M8; M9; M10; M12; M13; M14; M16 (100mm) M8; M9; M12 (140mm)
 - 1pc Ribe socket bit M10S (140mm)
 - 2pc M10 Alternator tools (674)
 - 1/2"DR. Spline (XZN) socket bit M10x110mm Reaction corkscrew cap 33teeth-Ø19mm-17mm hex
 - 2pc T50 Alternator tools (678)
 - 1/2"DR. Star socket bit T50x110mm Reaction corkscrew cap 33teeth-Ø19mm-17mm hex
 - 1pc Adaptor 1/2"(F)x3/8"(M)

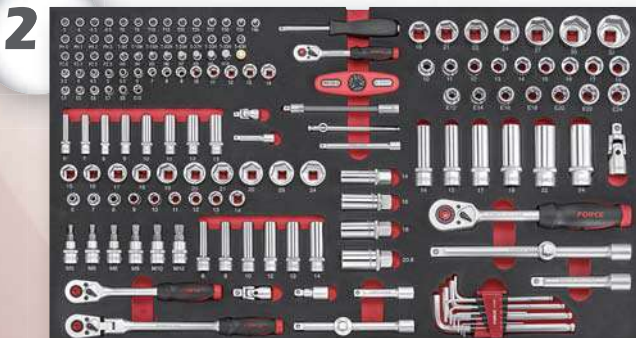

NO.41621

162pc 1/4" & 3/8" & 1/2" Socket combination set

- 1/4"DR. Part
- 14pc 6pt. Flank socket 3.2; 4; 4.5; 5; 5.5; 6; 7; 8; 9; 10; 11; 12; 13; 14 mm
 - 8pc 6pt. Flank deep socket (50mm) 6; 7; 8; 9; 10; 11; 12; 13 mm
 - 6pc Star socket E4; E5; E6; E7; E8; E10
 - 39pc Socket bit (32mm) Phillips PH.0; PH.1; PH.2; PH.3 Pozidriv PZ.0; PZ.1; PZ.2; PZ.3 Slotted 3; 4; 5.5; 6.5 mm Hex 3; 4; 5; 6; 7; 8; 9; 10 mm Star T8; T9; T10; T15; T20; T25; T27; T30; T35; T40 Star tamperproof T-8H; T-10H; T-15H; T-20H; T-25H; T-27H; T-30H; T-35H; T-40H
 - 1pc Quick-release pear ratchet handle 20teeth (802215)
 - 1pc T mini ratchet handle 48teeth (802220)
 - 2pc Extension 2"(50mm); 4"(100mm)
 - 1pc Sliding T handle 4.5"(115mm)
 - 1pc Universal joint
 - 1pc Flexible extension 5.8"(145mm)
 - 1pc Magnetic socket pick-up (25mm)
 - 1pc Spinner 6"(150mm) with 1/4"DR.(F)



NO.5505

50pc Wrench set

- 12pc Double open end wrench 6x7; 8x9; 10x11; 12x13; 14x15; 16x17; 18x19; 20x22; 21x23; 24x27; 25x28; 30x32 mm
- 26pc Combination wrench 6; 7; 8; 9; 10; 11; 12; 13; 14; 15; 16; 17; 18; 19; 20; 21; 22; 23; 24; 25; 26; 27; 28; 29; 30; 32 mm
- 12pc 75° Offset ring wrench 6x7; 8x9; 10x11; 12x13; 14x15; 16x17; 18x19; 20x22; 21x23; 24x27; 25x28; 30x32 mm

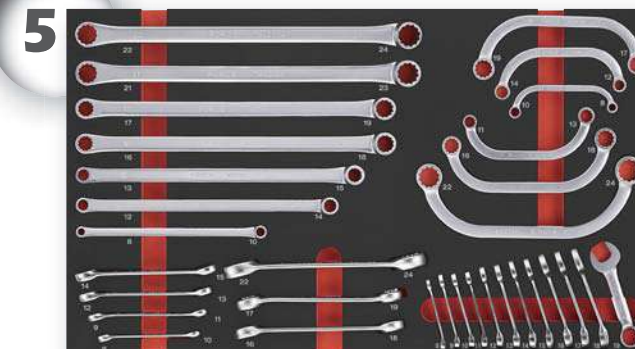

NO.5321

32pc Spanner set

- 7pc Flare nut wrench 8x10; 9x11; 12x13; 14x15; 16x18; 17x19; 22x24 mm
- 12pc Midjet combination wrench 8; 9; 10; 11; 12; 13; 14; 15; 16; 17; 18; 19 mm
- 7pc Extra-long flat ring wrench 8x10; 12x14; 13x15; 16x18; 17x19; 21x23; 22x24 mm
- 6pc Half-moon ring wrench 8x10; 11x13; 12x14; 16x18; 17x19; 22x24 mm



NO.5286

28pc Pliers and hammer chisel set

- 1pc Multi-purpose 4 points gripping pliers 11"(280mm)
- 4pc Chisel 12 (150mm); 15 (180mm); 19 (200mm); 25 (220mm)
- 5pc Pin punch 2 (140mm); 3 (150mm); 4 (190mm); 5 (200mm); 6 (210mm)
- 3pc Center punch 2.5 (185mm); 4 (185mm); 6 (185mm)
- 1pc Snap ring pliers internal 90° bent 7"(180mm)
- 1pc Snap ring pliers external 90° bent 7"(180mm)
- 1pc Snap ring pliers internal straight 7"(180mm)
- 1pc Snap ring pliers external straight 7"(180mm)
- 1pc Long nose pliers 8"(200mm)
- 1pc Combination pliers 7"(175mm)
- 1pc Diagonal pliers 7"(175mm)
- 1pc Waterpump pliers 10"(250mm)
- 1pc Locking pliers 10"(250mm)
- 1pc Engineer hammer 300gw
- 1pc Rubber hammer 520gw
- 1pc Adjustable gauged wrench 10"(250mm)
- 1pc Electrician folding knife
- 1pc Multi-functional stripper pliers
- 1pc Technician's scissors



NO.5292

29pc Hex grip key, nut driver & auto body tool set

- 10pc Hex & hex ball point grip key 2; 2.5; 3; 4; 5; 6; 7; 8; 10; 12 mm
- 9pc T-handle hex socket driver (260mm) 6; 7; 8; 9; 10; 11; 12; 13; 14 mm
- 1pc Pull type remover
- 1pc Wide type remover
- 1pc Upholstery clip remover
- 1pc Narrow type remover
- 1pc Handy remover
- 1pc Trim pad remover (big)
- 1pc Trim pad remover (small)
- 1pc Gasket scraper
- 1pc Radiator hose remover
- 1pc Cotter pin puller



NO.4791

79pc 1/2"DR. Impact socket & torque wrench set

- 19pc 6pt. Flank impact socket 8; 10; 11; 12; 13; 14; 15; 16; 17; 18; 19; 21; 22; 23; 24; 27; 30; 32; 36 mm
- 19pc 6pt. Flank deep impact socket (85mm) 8; 10; 11; 12; 13; 14; 15; 16; 17; 18; 19; 21; 22; 23; 24; 27; 30; 32; 36 mm
- 3pc Thin-wall 6pt. flank deep impact socket (85mm) 17; 19; 21 mm
- 3pc Colored 6pt. flank deep impact socket (85mm) 17; 19; 21 mm
- 10pc Hex impact socket bit (one-piece) (60mm) 4; 5; 6; 7; 8; 10; 12; 14; 17; 19 mm
- 10pc Star impact socket bit (one-piece) (60mm) T20; T25; T27; T30; T40; T45; T50; T55; T60; T70
- 3pc Spline impact socket bit (one-piece) (60mm) M8; M10; M12
- 4pc Spline impact socket bit (one-piece) (78mm) M12; M14; M16; M18
- 1pc Lock torque wrench 40-210 Nm, 535mm (6474535)
- 2pc Impact extension (ball type) 3"(75mm); 5"(125mm)
- 1pc Universal joint (ball type)
- 2pc Impact adaptor (ball type) 3/8"(F)x1/2"(M); 3/4"(F)x1/2"(M)
- 2pc Impact bit holder 1/2"(F)x1/4"(F); 1/2"(F)x5/16"(F)

■ 10318-531

■ 10318B-531

■ 10318R-531

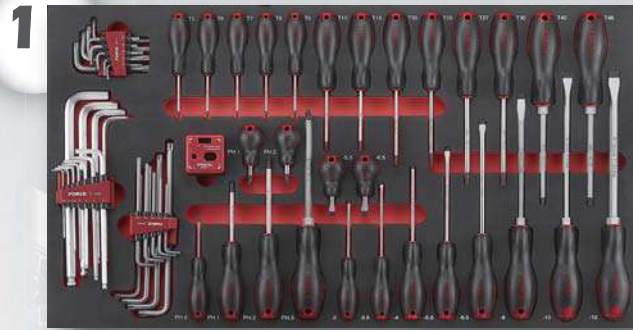

NO.2592

59pc Screwdriver and L key set

- 2pc Phillips stubby screwdriver PH.1; PH.2 (25mm)
- 4pc Phillips screwdriver PH.0 (60mm); PH.1 (80mm); PH.2 (100mm); PH.3 (150mm)
- 2pc Slotted stubby screwdriver 5.5; 6.5 mm (25mm)
- 6pc Slotted screwdriver 3mm (75mm); 3.5mm (100mm); 4mm (100mm); 5.5mm (125mm); 6.5mm (150mm); 8mm (175mm)
- 2pc Hammer slotted screwdriver 10; 12 mm (200mm)
- 13pc Star screwdriver T5 (60mm); T6 (60mm); T7 (60mm); T8 (60mm); T9 (60mm); T10 (80mm); T15 (80mm); T20 (100mm); T25 (100mm); T27 (115mm); T30 (115mm); T40 (130mm); T45 (130mm)
- 11pc Extra long hex ball point key (5116XLB) 1.5; 2; 2.5; 3; 4; 5; 6; 7; 8; 10; 12 mm
- 9pc Extra long star tamperproof key (5098XLT) T-10H; T-15H; T-20H; T-25H; T-27H; T-30H; T-40H; T-45H; T-50H
- 9pc Five-sided star tamperproof key (50913) TS10; TS15; TS20; TS25; TS27; TS30; TS40; TS45; TS50
- 1pc Demagnetizer / Magnetizer

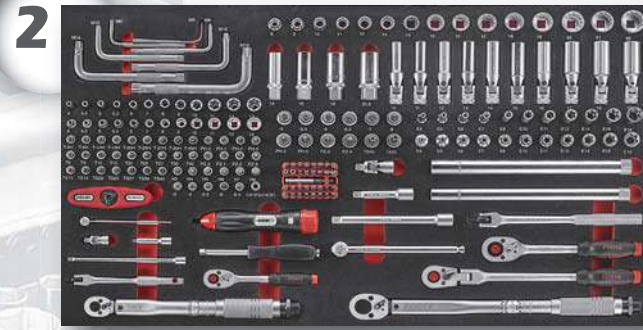

NO.31921

192pc 1/4" & 3/8" Socket combination set

- 1/4"DR. Part
- 12pc 6pt. Flank socket 4; 4.5; 5; 5.5; 6; 7; 8; 9; 10; 11; 12; 13 mm
- 12pc 6pt. Flank deep socket (50mm) 4; 4.5; 5; 5.5; 6; 7; 8; 9; 10; 11; 12; 13 mm
- 44pc Socket bit (32mm)
 - Phillips PH.0; PH.1; PH.2; PH.3
 - Pozidriv PZ.0; PZ.1; PZ.2; PZ.3
 - Slotted 3; 4; 5.5; 6; 6.5 mm
 - Hex 3; 4; 5; 6; 7; 8 mm
 - Star T8; T9; T10; T15; T20; T25; T27; T30; T40
 - Star tamperproof T-8H; T-9H; T-10H; T-15H; T-20H; T-25H; T-27H; T-30H; T-40H
 - Five-sided star tamperproof TS10; TS15; TS20; TS25; TS27; TS30; TS40
- 1pc Torque driver 2-8 Nm (64721608)
- 1pc Torque wrench 5-25 Nm, 270mm (6472270)
- 1pc Quick-release pear ratchet handle 24teeth (80222)
- 1pc T mini ratchet handle 48teeth (802220)
- 1pc Swivel handle 5.5"(140mm)
- 2pc Extension 2"(50mm); 6"(150mm)
- 1pc Sliding T handle 4.5"(115mm)
- 1pc Universal joint
- 1pc Bit holder 1/4"(F)x1/4"(F)
- 1pc Spinner 6"(150mm) with 1/4"DR. (F)

- 3/8"DR. Part
- 15pc 12pt. Flank socket 8; 9; 10; 11; 12; 13; 14; 15; 16; 17; 18; 19; 20; 21; 22 mm
- 11pc Star socket E4; E5; E6; E7; E8; E10; E11; E12; E14; E16; E18
- 4pc Star deep socket (55mm) E4; E5; E6; E7
- 7pc Star deep socket (63mm) E8; E10; E11; E12; E14; E16; E18
- 10pc Universal 6pt. flank deep socket (85mm) 10; 11; 12; 13; 14; 15; 16; 17; 18; 19 mm
- 4pc Spark plug socket 14; 16; 18; 20.6 mm
- 2pc Magnetic long spark plug socket (250mm) 14; 16 mm
- 12pc Socket bit (50mm)
 - Phillips PH.3; PH.4
 - Pozidriv PZ.3; PZ.4
 - Slotted 5; 5.5; 6; 6.5; 7; 8 mm
 - Five-sided star tamperproof TS45; TS50
- 1pc Torque wrench 20-110 Nm, 365mm (6473365)
- 1pc Quick-release pear ratchet handle 24teeth (80232)
- 1pc Quick-release flexible pear ratchet handle 30teeth (802318)
- 1pc Swivel handle 8.5"(215mm)
- 2pc Extension 3"(75mm); 6"(150mm)
- 1pc Sliding T handle 6.5"(165mm)
- 1pc Universal joint

- Bits (2331A)
- 32pc 1/4" Bit (25mm)
 - Torq set 2; 4; 6; 8; 10 mm; 1/4"
 - Tri-wing 1; 2; 3; 4 mm
 - Spanner 4; 6; 8; 10; 12; 14 mm
 - Square No.0; No.1; No.2; No.3
 - Hex security 2; 2.5; 3; 4; 5; 6 mm
 - Hex security 5/64"; 3/32"; 7/64"; 1/8"; 9/64"; 5/32"
- 1pc Magnetic bit holder 1/4"Hex-1/4"Hex 2.3"(60mm)

- Others:
- 7pc Spline key M5; M6; M8; M10; M12; M14; M16



NO.5505

50pc Wrench set

- 12pc Double open end wrench 6x7; 8x9; 10x11; 12x13; 14x15; 16x17; 18x19; 20x22; 21x23; 24x27; 25x28; 30x32 mm
- 26pc Combination wrench 6; 7; 8; 9; 10; 11; 12; 13; 14; 15; 16; 17; 18; 19; 20; 21; 22; 23; 24; 25; 26; 27; 28; 29; 30; 32 mm
- 12pc 75° Offset ring wrench 6x7; 8x9; 10x11; 12x13; 14x15; 16x17; 18x19; 20x22; 21x23; 24x27; 25x28; 30x32 mm



NO.5296

29pc Pliers and hammer chisel set

- 3pc Chisel 12 (150mm); 19 (200mm); 25 (220mm)
- 1pc Cape chisel (150mm)
- 7pc Pin punch 2 (140mm); 3 (150mm); 4 (190mm); 5 (200mm); 6 (210mm); 8 (215mm); 10 (230mm)
- 1pc Center punch 4 (185mm)
- 1pc Snap ring pliers internal 90° bent 7"(180mm)
- 1pc Snap ring pliers external 90° bent 7"(180mm)
- 1pc Snap ring pliers internal straight 7"(180mm)
- 1pc Snap ring pliers external straight 7"(180mm)
- 1pc Long nose pliers 8"(200mm)
- 1pc Bent long nose pliers 8"(200mm)
- 1pc Combination pliers 7"(180mm)
- 1pc Diagonal pliers 7"(180mm)
- 1pc Waterpump pliers 10"(250mm)
- 1pc Locking pliers 10"(250mm)
- 1pc Engineer hammer 300gw
- 1pc Rubber hammer 520gw
- 1pc Feeler gauges of 20 sizes (618)
- 1pc Adjustable gauged wrench 10"(250mm)
- 1pc Electrician folding knife
- 1pc Multi-functional stripper pliers
- 1pc Gasket scraper



8



NO.5461

46pc Wrench set

- 9pc Flare nut wrench 8x10; 9x11; 12x13; 14x15; 16x18; 17x19; 19x22; 24x27; 30x32 mm
- 12pc Midget combination wrench 8; 9; 10; 11; 12; 13; 14; 15; 16; 17; 18; 19 mm
- 6pc Star wrench E6xE8; E7xE11; E10xE12; E14xE18; E16xE22; E20xE24
- 12pc Reversible ratchet wrench 8; 9; 10; 11; 12; 13; 14; 15; 16; 17; 18; 19 mm
- 7pc Extra-long ring wrench 8x10; 12x14; 13x15; 16x18; 17x19; 21x23; 22x24



NO.5292

29pc Hex grip key, nut driver & auto body tool set

- 10pc Hex & hex ball point grip key 2; 2.5; 3; 4; 5; 6; 7; 8; 10; 12 mm
- 9pc T-handle hex socket driver (260mm) 6; 7; 8; 9; 10; 11; 12; 13; 14 mm
- 1pc Pull type remover
- 1pc Wide type remover
- 1pc Upholstery clip remover
- 1pc Narrow type remover
- 1pc Handy remover
- 1pc Trim pad remover (big)
- 1pc Trim pad remover (small)
- 1pc Gasket scraper
- 1pc Radiator hose remover
- 1pc Cotter pin puller

NO.4891

89pc 1/2"DR. Impact socket & socket bit set

- 27pc 6pt. Flank impact socket 8; 9; 10; 11; 12; 13; 14; 15; 16; 17; 18; 19; 20; 21; 22; 23; 24; 25; 26; 27; 28; 30; 32; 33; 34; 35; 36 mm
- 27pc 6pt. Flank deep impact socket (85mm) 8; 9; 10; 11; 12; 13; 14; 15; 16; 17; 18; 19; 20; 21; 22; 23; 24; 25; 26; 27; 28; 30; 32; 33; 34; 35; 36 mm
- 3pc Colored 6pt. flank deep impact socket (85mm) 17; 19; 21 mm
- 10pc Hex impact socket bit (one-piece) (60mm) 4; 5; 6; 7; 8; 10; 12; 14; 17; 19
- 10pc Star impact socket bit (one-piece) (60mm) T20; T25; T27; T30; T40; T45; T50; T55; T60; T70
- 3pc Spline impact socket bit (one-piece) (60mm) M8; M10; M12
- 3pc Spline impact socket bit (one-piece) (78mm) M14; M16; M18
- 1pc Torque wrench 42-210 Nm, 470mm (6474470)
- 2pc Impact extension (ball type) 5"(125mm); 10"(250mm)
- 1pc Universal joint (ball type)
- 2pc Impact adaptor (ball type) 3/8"(F)x1/2"(M); 3/4"(F)x1/2"(M)



NO.32031
203pc Screwdriver, L key, 1/4" & 3/8" socket combination set

- 1/4"DR. Part
 12pc 6pt. Flank socket 4; 4.5; 5; 5.5; 6; 7; 8; 9; 10; 11; 12; 13 mm
 12pc 6pt. Flank deep socket (50mmL)
 4; 4.5; 5; 5.5; 6; 7; 8; 9; 10; 11; 12; 13 mm
 46pc Socket bit (32mmL)
 • Phillips PH.0; PH.1; PH.2; PH.3
 • Pozidriv PZ.0; PZ.1; PZ.2; PZ.3
 • Slotted 3; 4; 5.5; 6; 6.5 mm
 • Hex 3; 4; 5; 6; 7; 8; 9; 10 mm
 • Star T8; T9; T10; T15; T20; T25; T27; T30; T40
 • Star tamperproof
 T-8H; T-9H; T-10H; T-15H; T-20H; T-25H; T-27H; T-30H; T-40H
 • Five-sided star tamperproof
 TS10; TS15; TS20; TS25; TS27; TS30; TS40
 1pc Quick-release pear ratchet handle 24teeth (80222)
 1pc Swivel handle 5.5"(140mm)
 2pc Extension 2"(50mm); 6"(150mm)
 1pc Sliding T handle 4.5"(115mm)
 1pc Universal joint
 1pc Bit adaptor 1/4"Hex-1/4"Sq.
 1pc Adaptor 1/4"(F)x3/8"(M)
 1pc Bit holder 1/4"(F)x1/4"(F)
 1pc Flexible extension 5.8"(145mm)
 1pc Spinner 6"(150mm) with 1/4"DR.(F)

- 3/8"DR. Part
 15pc 6pt. Flank socket
 8; 9; 10; 11; 12; 13; 14; 15; 16; 17; 18; 19; 20; 21; 22 mm
 11pc Star socket
 E4; E5; E6; E7; E8; E10; E11; E12; E14; E16; E18
 4pc Star deep socket (55mmL) E4; E5; E6; E7
 7pc Star deep socket (63mmL) E8; E10; E11; E12; E14; E16; E18
 4pc Spark plug socket 14; 16; 18; 20.6 mm
 12pc Socket bit (50mmL)
 • Phillips PH.3; PH.4
 • Pozidriv PZ.3; PZ.4
 • Slotted 5; 5.5; 6; 6.5; 7; 8 mm
 • Five-sided star tamperproof TS45; TS50
 1pc Quick-release pear ratchet handle 24teeth (80232)
 1pc Swivel handle 8.5"(215mm)
 2pc Extension 3"(75mm); 6"(150mm)
 1pc Sliding T handle 6.5"(165mm)
 1pc Universal joint
 2pc Adaptor 3/8"(F)x1/4"(M); 1/2"(F)x3/8"(M)

- Bits (2331A)
 32pc 1/4" Bit (25mmL)
 • Torq set 2; 4; 6; 8; 10 mm; 1/4"
 • Tri-wing 1; 2; 3; 4 mm
 • Spanner 4; 6; 8; 10; 12; 14 mm
 • Square No.0; No.1; No.2; No.3
 • Hex security 2; 2.5; 3; 4; 5; 6 mm
 • Hex security 5/64"; 3/32"; 7/64"; 1/8"; 9/64"; 5/32"
 1pc Magnetic bit holder 1/4"Hex-1/4"lnhex 2.3"(60mm)

- Others:
 3pc Hammer phillips screwdriver
 PH.1 (80mmL); PH.2 (100mmL); PH.3 (150mmL)
 5pc Hammer slotted screwdriver
 5.5mm (125mmL); 6.5mm (150mmL); 8mm (150mmL);
 10mm (200mmL); 12mm (200mmL)
 11pc Extra long hex ball point key (5116XLB)
 1.5; 2; 2.5; 3; 4; 5; 6; 7; 8; 10; 12 mm
 9pc Extra long star key (5098XL)
 T10; T15; T20; T25; T27; T30; T40; T45; T50

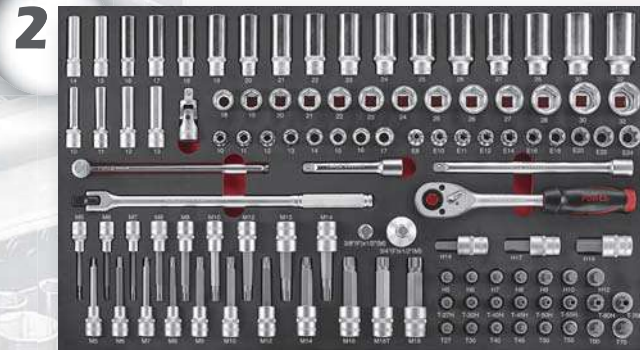

NO.41062
106pc 1/2"DR. Socket combination set

- 21pc 6pt. Flank socket
 10; 11; 12; 13; 14; 15; 16; 17; 18; 19; 20;
 21; 22; 23; 24; 25; 26; 27; 28; 30; 32 mm
 21pc 6pt. Flank deep socket (77mmL)
 10; 11; 12; 13; 14; 15; 16; 17; 18; 19; 20;
 21; 22; 23; 24; 25; 26; 27; 28; 30; 32 mm
 10pc Star socket E8; E10; E11; E12; E14; E16; E18; E20; E22; E24
 7pc Hex socket bit (55mmL) 5; 6; 7; 8; 9; 10; 12 mm
 1pc Hex socket bit (65mmL) 14mm
 2pc Hex socket bit (70mmL) 17; 19 mm
 8pc Star socket bit (55mmL) T27; T30; T40; T45; T50; T55; T60; T70
 8pc Star tamperproof socket bit (55mmL)
 T-27H; T-30H; T-40H; T-45H; T-50H; T-55H; T-60H; T-70H
 10pc Spline socket bit (100mmL)
 M5; M6; M7; M8; M9; M10; M12; M14; M16; M18
 1pc Spline security socket bit (100mmL) M16
 9pc Ribe socket bit (100mmL)
 M5; M6; M7; M8; M9; M10; M12; M13; M14
 1pc Quick-release pear ratchet handle 24teeth (80242)
 1pc Swivel handle 15"(380mm)
 2pc Extension 5"(125mm); 10"(250mm)
 1pc Sliding T handle 10"(250mm)
 1pc Universal joint
 2pc Adaptor 3/8"(F)x1/2"(M); 3/4"(F)x1/2"(M)



NO.41001
100pc 1/2"DR. Impact socket set

- 24pc 6pt. Flank impact socket
 8; 9; 10; 11; 12; 13; 14; 15; 16; 17; 18; 19; 20;
 21; 22; 23; 24; 25; 26; 27; 28; 29; 30; 32 mm
 24pc 6pt. Flank deep impact socket (85mmL)
 8; 9; 10; 11; 12; 13; 14; 15; 16; 17; 18; 19; 20;
 21; 22; 23; 24; 25; 26; 27; 28; 29; 30; 32 mm
 5pc Colored 6pt. flank deep impact socket (85mmL)
 17; 19; 21; 22; 24 mm
 12pc Star impact socket
 E6; E7; E8; E10; E11; E12; E14; E16; E18; E20; E22; E24
 14pc Hex impact socket bit (one-piece) (60mmL)
 4; 5; 6; 7; 8; 10; 12; 14; 16; 17; 19; 21; 22; 24 mm
 10pc Star impact socket bit (one-piece) (60mmL)
 T20; T25; T27; T30; T40; T45; T50; T55; T60; T70
 3pc Spline impact socket bit (one-piece) (60mmL) M8; M10; M12
 3pc Spline impact socket bit (one-piece) (78mmL) M14; M16; M18
 2pc Impact extension (ball type) 5"(125mm); 10"(250mm)
 1pc Universal joint (ball type)
 2pc Impact adaptor (ball type) 3/8"(F)x1/2"(M); 3/4"(F)x1/2"(M)



NO.5422
42pc Combination wrench set

- 30pc Combination wrench
 6; 7; 8; 9; 10; 11; 12; 13; 14; 15; 16; 17; 18; 19; 20; 21;
 22; 23; 24; 25; 26; 27; 28; 29; 30; 32; 33; 34; 36; 38 mm
 12pc Midget combination wrench
 8; 9; 10; 11; 12; 13; 14; 15; 16; 17; 18; 19 mm



NO.5522
52pc Spanner set

- 9pc Flare nut wrench
 8x10; 9x11; 12x13; 14x15; 16x18; 17x19; 19x22; 24x27; 30x32 mm
 13pc Double open wrench
 6x7; 8x9; 10x11; 12x13; 14x15; 16x17; 18x19;
 20x22; 21x23; 24x26; 25x28; 27x30; 32x36 mm
 17pc Flat ratchet wrench
 8; 9; 10; 11; 12; 13; 14; 15; 16; 17; 18; 19; 20; 21; 22; 23; 24 mm
 8pc 45° Offset ring wrench
 8x9; 10x11; 12x13; 14x15; 16x17; 18x19; 21x23; 22x24 mm
 5pc Half-moon ring wrench 8x10; 11x13; 12x14; 13x15; 17x19 mm



NO.6342
34pc 3/4"DR. Socket set

- 17pc 12pt. Flank socket
 17; 19; 21; 22; 23; 24; 27; 30; 32; 33; 34; 35; 36; 38; 41; 46; 50 mm
 5pc Hex socket bit (80mmL) 14; 16; 17; 19; 22 mm
 5pc Star socket bit (80mmL) T60; T70; T80; T90; T100
 1pc Quick-release pear ratchet handle 24teeth (8026500)
 2pc Extension 8"(200mm); 16"(400mm)
 1pc Sliding T handle 20"(500mm)
 2pc Adaptor 1/2"(F)x3/4"(M); 1"(F)x3/4"(M)
 1pc L handle 18"(450mm)



NO.6431
43pc 3/4"DR. Impact socket set

- 17pc 6pt. Flank impact socket
 17; 19; 21; 22; 23; 24; 27; 28; 30; 32; 33; 34; 35; 36; 38; 41; 46 mm
 17pc 6pt. Flank deep impact socket (100mmL)
 17; 19; 21; 22; 23; 24; 27; 28; 30; 32; 33; 34; 35; 36; 38; 41; 46 mm
 4pc Star deep impact socket (110mmL)
 E18; E20; E22; E24
 2pc Impact extension (ball type) 7"(175mm); 10"(250mm)
 2pc Impact adaptor (ball type) 1/2"(F)x3/4"(M); 1"(F)x3/4"(M)
 1pc Universal joint (ball type)



NO.5272
27pc Pliers, hammer, chisel and file set

- 1pc Utility knife (include 3pc blades)
 1pc Flat file 8"(200mm)
 1pc Half round file 8"(200mm)
 1pc Round file 8"(200mm)
 1pc Triangular file 8"(200mm)
 1pc 5m auto-stop measuring tape
 3pc Quakeproof chisel
 12 (150mmL); 19 (200mmL); 25 (220mmL)
 1pc Quakeproof cape chisel (150mmL)
 7pc Quakeproof pin punch
 2 (140mmL); 3 (150mmL); 4 (190mmL); 5 (200mmL);
 6 (210mmL); 8 (215mmL); 10 (230mmL)
 1pc Quakeproof center punch 4 (185mmL)
 1pc Long nose pliers 8"(200mm)
 1pc Bent long nose pliers 8"(200mm)
 1pc Combination pliers 7"(175mm)
 1pc Diagonal pliers 7"(175mm)
 1pc Waterpump pliers 10"(250mm)
 1pc Locking pliers 10"(250mm)
 1pc Engineer hammer 500gw
 1pc Sledge hammer 1250gw
 1pc Gasket scraper

■ 10318-607

■ 10318B-607

■ 10318R-607

Part No.	Page	Part No.	Page	Part No.	Page	Part No.	Page
1013-562	2-22	10210H3	1-48	10217A-245	2-14	10218A-286	2-16
1013A-562	2-22	10210H4	1-48	10217A-286	2-16	10218A-302	2-15
1013B-562	2-22	10215	2-9	10217A-302	2-15	10218A-308	4-5
1013R-562	2-22	10215-210	2-12	10217A-308	4-5	10218A-325	2-17
102101	2-1	10215-219	2-13	10217A-325	2-17	10218A-345	2-20
102101	2-8	10215A	2-9	10217A-345	2-20	10218A-361	2-18
102101	2-24	10215A-210	2-12	10217A-361	2-18	10218A-370	4-8
102101B	2-1	10215A-219	2-13	10217A-376	2-19	10218A-376	2-19
102101B	2-8	10215B	2-9	10217B	2-10	10218A-405	4-9
102101B	2-24	10215B-210	2-12	10217B-210	2-12	10218B	2-10
102101R	2-8	10215B-219	2-13	10217B-219	2-13	10218B-210	2-12
102101R	2-1	10215R	2-9	10217B-245	2-14	10218B-219	2-13
102101R	2-24	10215R-210	2-12	10217B-286	2-16	10218B-245	2-14
102102	2-1	10215R-219	2-13	10217B-302	2-15	10218B-286	2-16
102102	2-8	10216	2-9	10217B-308	4-5	10218B-302	2-15
102102	2-24	10216-210	2-12	10217B-325	2-17	10218B-308	4-5
102102B	2-1	10216-219	2-13	10217B-345	2-20	10218B-325	2-17
102102B	2-8	10216-245	2-14	10217B-361	2-18	10218B-345	2-20
102102B	2-24	10216A	2-9	10217B-376	2-19	10218B-361	2-18
102102R	2-1	10216A-210	2-12	10217R	2-10	10218B-370	4-8
102102R	2-8	10216A-219	2-13	10217R-210	2-12	10218B-376	2-19
102102R	2-24	10216A-245	2-14	10217R-219	2-13	10218B-405	4-9
102103P	2-7	10216B	2-9	10217R-245	2-14	10218R	2-10
102104	2-1	10216B-210	2-12	10217R-286	2-16	10218R-210	2-12
102104	2-8	10216B-219	2-13	10217R-302	2-15	10218R-219	2-13
102104	2-24	10216B-245	2-14	10217R-308	4-5	10218R-245	2-14
102104B	2-1	10216R	2-9	10217R-325	2-17	10218R-286	2-16
102104B	2-8	10216R-210	2-12	10217R-345	2-20	10218R-302	2-15
102104B	2-24	10216R-219	2-13	10217R-361	2-18	10218R-308	4-5
102104R	2-1	10216R-245	2-14	10217R-376	2-19	10218R-325	2-17
102104R	2-8	10217	2-10	10218	2-10	10218R-345	2-20
102104R	2-24	102170BBS	2-8	10218-210	2-12	10218R-361	2-18
102105	2-1	102170LK	2-7	10218-219	2-13	10218R-370	4-8
102105	2-8	102170LK	2-23	10218-245	2-14	10218R-376	2-19
102105	2-24	10217-210	2-12	10218-286	2-16	10218R-405	4-9
102105B	2-1	10217-219	2-13	10218-302	2-15	10225	2-11
102105B	2-8	10217-245	2-14	10218-308	4-5	10225A	2-11
102105B	2-24	10217-286	2-16	10218-325	2-17	10225B	2-11
102105R	2-1	10217-302	2-15	10218-345	2-20	10225R	2-11
102105R	2-8	10217-308	4-5	10218-361	2-18	103106	2-23
102105R	2-24	10217-325	2-17	10218-370	4-8	103106B	2-23
102106	2-7	10217-345	2-20	10218-376	2-19	103106R	2-23
102106A	2-7	10217-361	2-18	10218-405	4-9	10318	2-25
102106B	2-7	10217-376	2-19	10218A	2-10	103180BBS	2-24
102106R	2-7	10217A	2-10	10218A-210	2-12	103180BG	2-23
10210H1	1-48	10217A-210	2-12	10218A-219	2-13	103180RG	2-23
10210H2	1-48	10217A-219	2-13	10218A-245	2-14	103180G	2-23

Part No.	Page	Part No.	Page	Part No.	Page	Part No.	Page
103180P	2-23	20914	1-19	4215	3-21	50910BS	3-46
10318-437	2-26	20917	3-6	4572	1-27	50911	3-29
10318-531	4-12	2095	3-45	4615	4-8	50912	3-47
10318-552	2-28	2095S	3-45	4662	4-10	50919	3-48
10318-607	4-16	2096	3-45	4685	4-7	51010T	3-47
10318-610	4-13	2097	3-44	4721-5	1-18	51012	1-19
10318B	2-25	2097B	3-44	4791	4-12	5106B	3-46
10318B-437	2-26	2097S	3-44	4882	4-5	51223	1-25
10318B-531	4-12	2108	3-2	4891	4-14	5138	3-39
10318B-552	2-28	2109	3-2	50212	1-45	5139	3-39
10318B-607	4-16	2125N	3-6	50223	1-45	5168	4-10
10318B-610	4-13	21261	4-9	50223R	1-45	5178	4-10
10318R	2-25	2126N	3-6	50223S	1-17	5179	4-8
10318R-437	2-26	2134	3-4	50223S-109	1-22	5184	1-26
10318R-531	4-12	2137	3-3	50223S-116-5	1-18	5207	4-6
10318R-552	2-28	2137T	3-4	50223S-147	1-20	5207	4-8
10318R-607	4-16	2141	3-44	50229S	1-17	5207	4-10
10318R-610	4-13	2141T	3-45	50229S-255	1-24	5225	4-2
10323	2-25	2142	3-1	50230-95	1-1	5225	4-4
10323B	2-25	2143	3-1	50231-33	1-2	5243	1-23
10323R	2-25	2145	1-24	50233	1-5	5252	1-19
105106	2-1	2146	1-22	50233-25	1-12	5262	1-22
105106L	2-1	2195	4-6	50233-76	1-11	5272	4-16
10517	2-1	2208	4-1	50233-80	1-5	5273	4-4
10517-199	4-1	2262	4-9	50234	1-3	5281	1-27
10517-229	4-2	2371	4-11	50234-107	1-4	5286	4-12
10517-285	2-2	2407	4-3	50235	1-5	5292	4-12
10517-305	2-3	2412	4-5	50235-88	1-12	5292	4-14
10517-310	2-4	2415	4-2	50235-101	1-11	5296	4-14
10517-337	2-5	2415	4-7	50235-110	1-12	5321	4-12
10517-386	4-3	2592	4-13	50235-112	1-11	5353	4-8
10517B	2-1	31101	1-26	50235-124	1-11	5361	4-4
10517B-199	4-1	31561	4-3	50235-152	1-7	5363	4-1
10517B-229	4-2	31921	4-13	50235-187	1-7	5363	4-2
10517B-285	2-2	32031	4-15	50253	1-46	5363	4-6
10517B-305	2-3	3451V	1-23	50253-177	1-46	5363	4-10
10517B-310	2-4	3981	4-9	50254	1-46	54111	3-43
10517B-337	2-5	41001	4-15	50254-177	1-47	5422	4-16
10517B-386	4-3	41041	4-6	50352	1-43	5461	4-14
10523	1-29	41051	4-4	50352-129	1-43	5505	4-12
10523-131	1-30	41062	4-15	5043AV	1-25	5505	4-14
10526	1-29	41141	4-11	5048	3-36	5522	4-16
10526-227	1-32	41162	4-13	50619	3-43	6342	4-16
10529	1-29	41281	4-7	5066V	1-25	6431	4-16
10529-303	1-35	41301	4-2	5066SV	1-25	82022D	1-48
1052D	1-29	41432	4-1	50713	3-43	82022DW	1-48
1052D-297	1-39	41621	4-11	50816	3-48	82023D	1-48

Part No.	Page	Part No.	Page	Part No.	Page	Part No.	Page
82023S	1-48	T3212	3-13	T4256	3-21	T50817	3-29
82023U	1-48	T3224	3-12	T4281	3-17	T5081S	3-28
82026D	1-48	T3251	3-10	T4322	3-18	T5082	3-23
82026S	1-48	T3251-5	3-10	T4355	3-17	T50822	3-37
82026U	1-48	T3251-5-8	3-10	T4411	3-18	T5085	3-27
82028U	1-48	T3251-5-15	3-10	T4413	3-18	T5085S	3-27
C20913N	1-13	T3251-5-18	3-10	T4583	3-19	T5089	3-26
C21114	1-13	T3251-72	3-10	T5021	3-33	T50918	3-23
C2193N	1-13	T3251-72-5	3-10	T5023	3-33	T5096	3-40
C3661	1-14	T3311	3-11	T5033	3-24	T5111	3-25
C4482	1-13	T3322	3-13	T5034	3-34	T51115	3-32
C4542	1-14	T3322-15	3-13	T5036	3-33	T5111S	3-25
C50412	1-15	T3322-23	3-13	T5036A	3-34	T5114	3-25
C51220	1-16	T3322-24	3-13	T5038	3-33	T51210	3-30
C51221	1-16	T3331	3-11	T50410	3-35	T51211	3-31
C5136	1-16	T3361	3-11	T5043A	3-35	T51214	3-27
C5142	1-15	T3381	3-12	T5044	3-28	T51215	3-30
C5153	1-15	T3382	3-12	T5045	3-34	T51215R	3-31
C5166	1-15	T3382T	3-12	T5046	3-34	T5122	3-41
C5206	1-15	T3382TT	3-12	T5047	3-35	T51226	3-28
T2045	3-8	T3521	3-12	T5052	3-26	T51226A	3-29
T20610A	3-2	T4057	3-14	T5053	3-36	T51229	3-38
T20612	3-4	T4057-15	3-14	T5053A	3-36	T5131	3-38
T20612N	3-6	T40612	3-14	T5053AF	3-37	T51315	3-32
T20712N	3-5	T40613-23	3-14	T5053F	3-37	T5134	3-27
T20715N	3-5	T40813	3-20	T5055	3-40	T5135S	3-24
T20718N	3-5	T40813-5	3-20	T5056	3-40	T5161	3-26
T20810	3-2	T4116	3-17	T5057	3-35	T5164	3-30
T20810B	3-3	T4119	3-20	T50616S	3-24	T5164R	3-31
T2084	3-1	T4122	3-17	T50617	3-32	T5172	3-23
T2085	3-1	T4143	3-15	T50618-18	3-42	T5181	3-26
T2086	3-3	T4143-9	3-15	T50618-24	3-42	T51811	3-42
T2086T	3-3	T4165	3-16	T50633AF	3-37	T5303	3-7
T20916N	3-5	T41710	3-16	T50634	3-29	T5303S	3-7
T2173A	3-7	T4179	3-16	T50636	3-47	T5331	3-41
T2641	3-8	T4193	3-20	T50637	3-46	T5861	3-42
T2641-8	3-8	T4194	3-19	T50710	3-23	T6085	3-22
T2641-15	3-8	T4203	3-16	T50723A	3-38	T6121	3-22
T2741	3-9	T4205	3-21	T50725	3-39	T8151	3-22
T2742	3-9	T4212	3-15	T5074	3-24	T905M2	3-43
T2742-8	3-9	T4212-7	3-15	T5075	3-25		
T2742-15	3-9	T4212-9	3-15	T5081	3-28		
T2742-18	3-9	T4217	3-15	T50810	3-32		
T30712	3-10	T4226	3-14	T50811	3-32		
T31010	3-41	T4226Q	3-14	T50812	3-30		
T3121	3-11	T4248	3-15	T50813	3-31		
T3193	3-13	T4248S	3-19	T50814	3-36		



General Information

This catalogue replaces all previous editions. All rights reserved in all countries. Reprinting and excerpts require a prior permission in writing by Shyang Yun Tools Co., Ltd.

The photographs and the technical details are of the articles at present offered.

Since we are constantly updating and improving our products to meet user needs and technological developments, we reserve the right to make modifications and changes with regard to photographs, specifications, sizes, packing, weights and performance without notice.

There is no liability for printing errors and correction or replacement supplies with regard to products already delivered.

Cancellations of all models and sets may be made at any time without there being any grounds for legal claim.

FORCE is a registered trademark.

All other trademarks mentioned in this document or website are the property of their respective owners.

The use of the word partner does not imply a partnership relationship between Shyang Yun Tools Co., Ltd. and any other company.

© Copyright by Shyang Yun Tools Co., Ltd.
All rights reserved.





FORCE[®]

Shyang Yun Tools Co., Ltd.
Shyang Yun Hardware Co., Ltd.

No.161, Sitou Rd., Shengang Dist., Taichung City 42953, Taiwan

Tel: +886-4-25631268 Fax: +886-4-25632678

<http://www.force.com.tw> E-mail: info@force.com.tw

